

INNOVATION...

Seit 60 Jahren entwickelt und stellt die Andersen Shopper Manufaktur das Original der rollenden Einkaufstasche im familieneigenen Unternehmen in Satrup her. Die Andersen Produkte für Familie, Freizeit und Einkauf auch in Kombination mit dem Fahrrad vereinen seit jeher traditionell hochwertige, qualitative und innovative Lösungen für den individuellen Bedarf.

Shopper® stehen für Nachhaltigkeit und unterstützen den ökologischen Gedanken: weniger Plastiktüten und keinen Kraftstoff.

Nicht nur für die Umwelt, auch für die eigene Gesundheit lohnt es sich, das Auto auch mal stehen zu lassen und mit dem Shopper® egal ob zu Fuß, mit dem Fahrrad, mit Bus oder Bahn oder in Kombination loszuziehen.

Ein wunderbarer ‚Alleskönner‘ und ‚ökologischer Kofferraum‘ täglich und universell einsetzbar.

Wir wünschen Ihnen viel Freude beim Ausschauen.

Ihr Team der Andersen Shopper Manufaktur

For 60 years, Andersen Shopper Manufaktur has developed and produced the original of the rolling shopping bag in their family business in Satrup. The Andersen products for family, free time and shopping, even in combination with cycling, have always combined traditional high-value, quality and innovative solutions for individual needs.

Shopper® stand for sustainability and support ecological thinking: fewer plastic bags and no fuel.

But it's worth it to leave the car at home and go out with the Shopper®, not just for the environment, but also for your own health, whether on foot, on your bike, with the bus or train, or a combination of these.

A wonderful 'all-rounder' and 'ecological luggage compartment' for use every day and universally.

We hope you enjoy picking one out.

Your team at Andersen Shopper Manufaktur

Depuis 60 ans, l'entreprise Andersen Shopper Manufaktur conçoit et fabrique la version originale des sacs à provisions sur roulettes dans l'entreprise familiale à Satrup, dans le nord de l'Allemagne. Les produits d'Andersen pour la famille, les loisirs et les courses, également en combinaison avec le vélo, associent depuis toujours des solutions qualitatives, innovantes et haut de gamme dans le respect de la tradition, adaptées aux besoins de chacun.

Les Shopper® représentent la durabilité et soutiennent l'écologie : moins de sacs plastique et pas de carburant.

Pas seulement pour l'environnement, mais aussi pour sa propre santé, cela vaut le coup de laisser sa voiture au garage et de partir en vadrouille avec le Shopper®, que ce soit à pieds, en vélo, en bus ou en train, ou en effectuant une combinaison.

Un véritable « multitalents » et un « coffre écologique » utilisable au quotidien et pour tous les usages.

Nous vous souhaitons un bon shopping.

L'équipe d'Andersen Shopper Manufaktur



SHOPPER®

UNUS SHOPPER® FUN	4-7
UNUS SHOPPER®	8-13
TURA SHOPPER®	
Kugellagerrad / ball-bearing wheel / roue à roulement à billes · Ø 29cm	14-17
luftbereiftes Kugellagerrad / pneumatic ball-bearing wheel / roue pneumatique à roulement à billes · Ø 29cm	18-19
SCALA SHOPPER®	20-23
SCALA SHOPPER® PLUS	24-27
ALU STAR SHOPPER®	28-31
QUATTRO SHOPPER®	32-35

ROYAL SHOPPER®	
3-Speichenrad / 3-spoke wheel / roue à 3 rayons · Ø 25cm	36-41
Metallspeichenrad / spoked metal wheel / roue à rayons métalliques · Ø 25cm	42-43
Kugellagerrad / ball-bearing wheel / roue à roulement à billes · Ø 25cm	45-47
luftbereiftes Kugellagerrad / pneumatic ball-bearing wheel / roue pneumatique à roulement à billes · Ø 25cm	48-49
Kugellagerrad / ball-bearing wheel / roue à roulement à billes · Ø 29cm	50-51
luftbereiftes Kugellagerrad / pneumatic ball-bearing wheel / roue pneumatique à roulement à billes · Ø 29cm	52-53
ROYAL SHOPPER® PLUS	
Kugellagerrad / ball-bearing wheel / roue à roulement à billes · Ø 25cm	54-55
luftbereiftes Kugellagerrad / pneumatic ball-bearing wheel / roue pneumatique à roulement à billes · Ø 25cm	56-57



4



14



36

KOMFORT SHOPPER®	58-59
TREPPENSTEIGER SCALA SHOPPER®	
Treppensteigerrad / triple wheel / couronne à trois roues	60-63
TREPPENSTEIGER ROYAL SHOPPER®	
Treppensteigerrad / triple wheel / couronne à trois roues	64-67

SHOWTIME

KORB SHOPPER®	68-69
IPEK - SHOPPER® & BAGS	70-71
TRUCK - SHOPPER® & BAGS	72-73
LUV & BOJE - SHOPPER® SAILINGBAGS	74-75
ORTLIEB - SHOPPER®	76-77
KIDS SHOPPER®	78-79
NEWSCHOOL SHOPPER®	80-81

BIKE & EASY

KOFFERRAUM FÜR'S FAHRRAD / A TRUNK FOR THE BIKE / UN COFFRE POUR LE VÉLO.....	82
KUPPLUNGEN / COUPLINGS / ACCOUPLEMENTS	83-85
ZUBEHÖR / EXTRAS / ACCESSOIRES	86
DISPLAYS	87
FAHRRAD & FREIZEITANHÄNGER / BIKE TRAILER	
REMORQUES POUR VÉLO ET LES LOISIRS	88-89



58



82



98

FEATURES

SHOPPER® SERIEN / SHOPPER® SERIES / SÉRIES SHOPPER®	94-95
TASCHEN / BAGS / SACS	96-97
RAD / WHEEL / ROUE	97

TRANSPORT

TRANSPORT	90-91
ZEITUNGSRÖLLER / NEWSPAPER TROLLEY / CHARIOT À JOURNAUX	92-93

HISTORY

HISTORIE / HISTORY / HISTOIRE	98-100
-------------------------------------	--------



UNUS FUN
SHOPPER®
ALUMINIUM

FEATURES...

Als Fahrradanhänger einsetzbar
Can also be fitted to a bicycle
Utilisable comme remorque de vélo

siehe Seite/see page/voir page:
82-86



3-Wege-System Griff
3-way-system grip
Poignée à 3 positions



Abfaltbar und in
verschiedenen Stufen
arretierbar
Foldable and lockable
in different positions
Inclinable en plusieurs
positions avec système
de verrouillage



37
23
cm



VIDEO



VIDEO
GRIFF/GRIIP
POIGNÉE





GRAU/GREY/GRIS · ART.-NR.: 121-139-20



ROT/RED/ROUGE · ART.-NR.: 121-139-70

EIGENSCHAFTEN TASCHE · FEATURES BAG/ CARACTÉRISTIQUES DU SAC
 EIGENSCHAFTEN FAHRGESTELL · FEATURES FRAME/ CARACTÉRISTIQUES DU CHÂSSIS

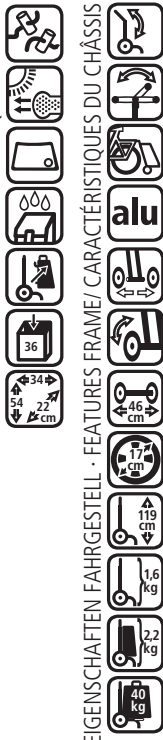

GRÜN/GREEN/VERT · ART.-NR.: 121-133-50



SCHWARZ/BLACK/NOIR · ART.-NR.: 121-133-80



ROT/RED/ROUGE · ART.-NR.: 121-133-70



TÜRKIS/TURQUOIS/TURQUOISE · ART.-NR.: 121-133-90

EIGENSCHAFTEN TASCHE · FEATURES BAG/ CARACTÉRISTIQUES DU SAC
 EIGENSCHAFTEN FAHRGESTELL · FEATURES FRAME/ CARACTÉRISTIQUES DU CHÂSSIS

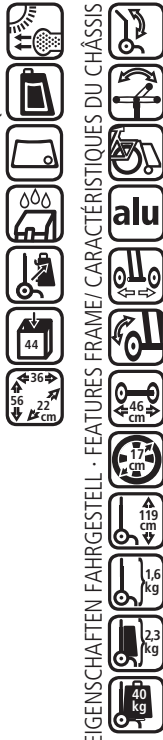



ROT/RED/ROUGE · ART.-NR.: 121-140-70

EIGENSCHAFTEN TASCHE · FEATURES BAG/ CARACTÉRISTIQUES DU SAC



EIGENSCHAFTEN FAHRGESTELL · FEATURES FRAME/ CARACTÉRISTIQUES DU CHÂSSIS



GRAU/GREY/GRIS · ART.-NR.: 121-127-20

EIGENSCHAFTEN TASCHE · FEATURES BAG/ CARACTÉRISTIQUES DU SAC



EIGENSCHAFTEN FAHRGESTELL · FEATURES FRAME/ CARACTÉRISTIQUES DU CHÂSSIS



GOLD/GOLD/OR · ART.-NR.: 121-128-00

EIGENSCHAFTEN TASCHE · FEATURES BAG/ CARACTÉRISTIQUES DU SAC



EIGENSCHAFTEN FAHRGESTELL · FEATURES FRAME/ CARACTÉRISTIQUES DU CHÂSSIS



BLAU/BLEU/NOIR · ART.-NR.: 121-140-90



SCHWARZ/BLACK/NOIR · ART.-NR.: 121-127-80



SCHWARZ/BLACK/NOIR · ART.-NR.: 121-128-80



SILBER/SILVER/ARGENT · ART.-NR.: 121-103-22

- EIGENSCHAFTEN TASCHE · FEATURES BAG/ CARACTÉRISTIQUES DU SAC
- -
 -
 -
 -
 -
 -
 -
 -
 -
 -
 -
 -
 -
 -
 -
 -
 -
 -
 -
- EIGENSCHAFTEN FAHRGESTELL · FEATURES FRAME/ CARACTÉRISTIQUES DU CHÂSSIS
- -
 -
 -
 -
 -
 -
 -
 -
 -
 -
 -
 -
 -
 -
 -
 -
 -
 -
 -



BLAU/BLEU · ART.-NR.: 121-103-92



SCHWARZ/BLACK/NOIR · ART.-NR.: 121-132-80

- EIGENSCHAFTEN TASCHE · FEATURES BAG/ CARACTÉRISTIQUES DU SAC
- -
 -
 -
 -
 -
 -
 -
 -
 -
 -
 -
 -
 -
 -
 -
 -
 -
 -
 -
- EIGENSCHAFTEN FAHRGESTELL · FEATURES FRAME/ CARACTÉRISTIQUES DU CHÂSSIS
- -
 -
 -
 -
 -
 -
 -
 -
 -
 -
 -
 -
 -
 -
 -
 -
 -
 -
 -



BLAU/BLEU · ART.-NR.: 121-132-90



LUV 12 · ART.-NR.: 121-090-12

- EIGENSCHAFTEN TASCHE · FEATURES BAG/ CARACTÉRISTIQUES DU SAC
- -
 -
 -
 -
 -
 -
 -
 -
 -
 -
 -
 -
 -
 -
 -
 -
 -
 -
 -
- EIGENSCHAFTEN FAHRGESTELL · FEATURES FRAME/ CARACTÉRISTIQUES DU CHÂSSIS
- -
 -
 -
 -
 -
 -
 -
 -
 -
 -
 -
 -
 -
 -
 -
 -
 -
 -
 -



LUV 28 · ART.-NR.: 121-090-28



UNUS
SHOPPER®
ALUMINIUM



FEATURES...

Als Fahrradanhänger einsetzbar
Can also be fitted to a bicycle
Utilisable comme remorque de vélo

siehe Seite/see page/voir page:
82-86



3-Wege-System Griff
3-way-system grip
Poignée à 3 positions



Teleskopstange stufenlos
verstellbar
Telescopic bar stepless adjustable
Barre de poignée télescopique
réglable en hauteur



Mit HängFix
With HängFix
Incl. HängFix





GRAU/GREY/GRIS ART.-NR.: 140-126-20

EIGENSCHAFTEN TASCHE · FEATURES BAG/ CARACTÉRISTIQUES DU SAC



EIGENSCHAFTEN FAHRGESTELL · FEATURES FRAME/ CARACTÉRISTIQUES DU CHÂSSIS



GRAU/GREY/GRIS · ART.-NR.: 140-130-20

EIGENSCHAFTEN TASCHE · FEATURES BAG/ CARACTÉRISTIQUES DU SAC



EIGENSCHAFTEN FAHRGESTELL · FEATURES FRAME/ CARACTÉRISTIQUES DU CHÂSSIS



ROT/RED/ROUGE · ART.-NR.: 140-140-70

EIGENSCHAFTEN TASCHE · FEATURES BAG/ CARACTÉRISTIQUES DU SAC



EIGENSCHAFTEN FAHRGESTELL · FEATURES FRAME/ CARACTÉRISTIQUES DU CHÂSSIS





GOLD/GOLD/OR ART.-NR.: 140-128-00



SCHWARZ/BLACK/NOIR · ART.-NR.: 140-128-80

- EIGENSCHAFTEN TASCHE · FEATURES BAG/ CARACTÉRISTIQUES DU SAC
- -
 -
 -
 -
 -
 -
 -
 -
 -
- EIGENSCHAFTEN FAHRGESTELL · FEATURES FRAME/ CARACTÉRISTIQUES DU CHÂSSIS
- -
 -
 -
 -
 -
 -



WEISS/WHITE/BLANC · ART.-NR.: 140-125-00



SCHWARZ/BLACK/NOIR · ART.-NR.: 140-125-80

- EIGENSCHAFTEN TASCHE · FEATURES BAG/ CARACTÉRISTIQUES DU SAC
- -
 -
 -
 -
 -
 -
 -
 -
 -
- EIGENSCHAFTEN FAHRGESTELL · FEATURES FRAME/ CARACTÉRISTIQUES DU CHÂSSIS
- -
 -
 -
 -
 -
 -



SILBER/SILVER/ARGENT · ART.-NR.: 140-103-22



BLAU/BLEU/BLEU · ART.-NR.: 140-103-92

- EIGENSCHAFTEN TASCHE · FEATURES BAG/ CARACTÉRISTIQUES DU SAC
- -
 -
 -
 -
 -
 -
 -
 -
 -
- EIGENSCHAFTEN FAHRGESTELL · FEATURES FRAME/ CARACTÉRISTIQUES DU CHÂSSIS
- -
 -
 -
 -
 -
 -



GRÜN/GREEN/VERT · ART.-NR.: 140-135-50



SCHWARZ/BLACK/NOIR · ART.-NR.: 140-135-80



ROT/RED/ROUGE · ART.-NR.: 140-135-70



TÜRKIS/TURQUOIS/TURQUOISE · ART.-NR.: 140-135-90

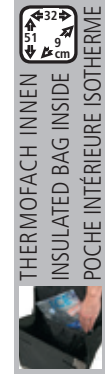

THERMOFACH INNEN
INSULATED BAG INSIDE
POCHE INTÉRIEURE ISOTHERME

- EIGENSCHAFTEN TASCHE · FEATURES BAG/ CARACTÉRISTIQUES DU SAC
- 36 cm
 - 43 cm
 - 58 cm
 - 22 cm
 - 32 cm
 - 40 kg
 - Shopping cart icon
- EIGENSCHAFTEN FAHRGESTELL · FEATURES FRAME/ CARACTÉRISTIQUES DU CHÂSSIS
- 126 cm
 - 23 kg
 - 32 kg
 - 40 kg
 - alu
 - Icons: Sun, Hand, Backpack, Laptop, Wheelchair, Lock, Key, Arrow



ROT/RED/ROUGE · ART.-NR.: 140-137-70



SCHWARZ/BLACK/NOIR · ART.-NR.: 140-137-80

- EIGENSCHAFTEN TASCHE · FEATURES BAG/ CARACTÉRISTIQUES DU SAC
- 39 cm
 - 58 cm
 - 35 cm
 - 22 cm
 - 30 kg
 - 40 kg
 - Shopping cart icon
- EIGENSCHAFTEN FAHRGESTELL · FEATURES FRAME/ CARACTÉRISTIQUES DU CHÂSSIS
- 126 cm
 - 23 kg
 - 30 kg
 - 40 kg
 - alu
 - Icons: Sun, Hand, Backpack, Laptop, Wheelchair, Lock, Key, Arrow



SILBER/SILVER/ARGENT · ART.-NR.: 140-136-20



GRAU/GREY/GRIS · ART.-NR.: 140-136-80



ROT/RED/ROUGE · ART.-NR.: 140-136-70



BLAU/BLUE/BLEU · ART.-NR.: 140-136-90



EIGENSCHAFTEN TASCHE · FEATURES BAG / CARACTÉRISTIQUES DU SAC



EIGENSCHAFTEN FAHRGESTELL · FEATURES FRAME / CARACTÉRISTIQUES DU CHÂSSIS



SILBER/SILVER/ARGENT · ART.-NR.: 140-141-20



GRAU/GREY/GRIS · ART.-NR.: 140-141-80



EIGENSCHAFTEN TASCHE · FEATURES BAG / CARACTÉRISTIQUES DU SAC



EIGENSCHAFTEN FAHRGESTELL · FEATURES FRAME / CARACTÉRISTIQUES DU CHÂSSIS

Tura
SHOPPER®
ALUMINIUM



VIDEO
GRIF/GRIP
POIGNÉE

VIDEO

TURA SHOPPER® ORTLIEB



SILBER/SILVER/ARGENT · ART.-NR.: 135-082-21

TASCHE / BAG / SAC
MADE BY
ORTLIEB

WATERPROOF



LIMONE/LIME/LIMON · ART.-NR.: 135-082-51



ROT/RED/ROUGE · ART.-NR.: 135-082-71



SCHWARZ/BLACK/NOIR · ART.-NR.: 135-082-81

EIGENSCHAFTEN TASCHЕ · FEATURES BAG / CARACTÉRISTIQUES DU SAC



EIGENSCHAFTEN FAHRGESTELL · FEATURES FRAME / CARACTÉRISTIQUES DU CHÂSSIS



TURA SHOPPER® BOJE



BOJE 8 · ART.-NR.: 135-092-08

EIGENSCHAFTEN TASCHЕ · FEATURES BAG / CARACTÉRISTIQUES DU SAC



EIGENSCHAFTEN FAHRGESTELL · FEATURES FRAME / CARACTÉRISTIQUES DU CHÂSSIS



BOJE 9 · ART.-NR.: 135-092-09

TURA SHOPPER® CLINT



GRÜN/GREEN/VERT · ART.-NR.: 136-142-50



ROT/RED/ROUGE · ART.-NR.: 136-142-70

EIGENSCHAFTEN TASCHE · FEATURES BAG/ CARACTÉRISTIQUES DU SAC



EIGENSCHAFTEN FAHRGESTELL · FEATURES FRAME/ CARACTÉRISTIQUES DU CHÂSSIS



TURA SHOPPER® HYDRO

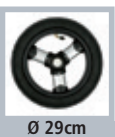

GRÜN/GREEN/VERT · ART.-NR.: 136-036-50



SCHWARZ/BLACK/NOIR · ART.-NR.: 136-036-80



ROT/RED/ROUGE · ART.-NR.: 136-036-70



TÜRKIS/TURQUOIS/TURQUOISE · ART.-NR.: 136-036-90

EIGENSCHAFTEN TASCHE · FEATURES BAG/ CARACTÉRISTIQUES DU SAC



EIGENSCHAFTEN FAHRGESTELL · FEATURES FRAME/ CARACTÉRISTIQUES DU CHÂSSIS



ALS RUCKSACK VERWENDBAR
CAN BE USED AS RUCKSACK
UTILISABLE COMME SAC À DOS



THERMOFACH INNEN
INSULATED BAG INSIDE
POCHÉ INTÉRIEURE ISOTHERME



TURA SHOPPER® FADO



GRÜN/GREEN/VERT · ART.-NR.: 136-143-50

EIGENSCHAFTEN TASCHE · FEATURES BAG / CARACTÉRISTIQUES DU SAC



THERMOFACH INNEN
INSULATED BAG INSIDE
POCHE INTÉRIEURE ISOTHERME



ROT/RED/ROUGE · ART.-NR.: 136-143-70

TURA SHOPPER® ORTLIEB

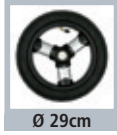

SILBER/SILVER/ARGENT · ART.-NR.: 136-082-21

TASCHE / BAG / SAC
MADE BY
ORTLIEB

WATERPROOF



ROT/RED/ROUGE · ART.-NR.: 136-082-71



LIMONE / LIME / LIMON · ART.-NR.: 136-082-51

EIGENSCHAFTEN TASCHE · FEATURES BAG / CARACTÉRISTIQUES DU SAC



EIGENSCHAFTEN FAHRGESTELL · FEATURES FRAME / CARACTÉRISTIQUES DU CHÂSSIS



SCHWARZ/BLACK/NOIR · ART.-NR.: 136-082-81



FEATURES...

Als Fahrradanhänger einsetzbar
Can also be fitted to a bicycle
Utilisable comme remorque de vélo

siehe Seite/see page/voir page:
82-86

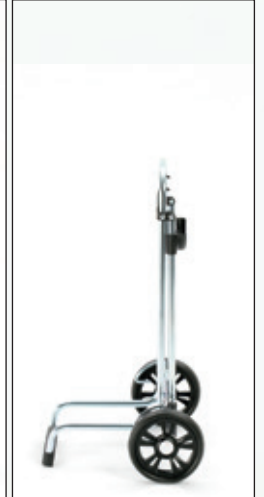

Scala
SHOPPER®





SILBER/SILVER/ARGENT · ART.-NR.: 112-004-22



ROT/RED/ROUGE · ART.-NR.: 112-004-72



GRAU/GREY/GRIS · ART.-NR.: 112-004-82



BLAU/BLUE/BLEU · ART.-NR.: 112-004-92

EIGENSCHAFTEN TASCHE · FEATURES BAG/ CARACTÉRISTIQUES DU SAC
 44
 36
 22
 cm
 45
 cm
 45
 cm
 1,9
 kg
 2,7
 kg
 40
 kg

EIGENSCHAFTEN FAHRGESTELL · FEATURES FRAME/ CARACTÉRISTIQUES DU CHÂSSIS
 101
 cm
 101
 cm
 1,9
 kg
 2,5
 kg
 40
 kg



GRAU/GREY/GRIS · ART.-NR.: 112-139-20



ROT/RED/ROUGE · ART.-NR.: 112-139-70

EIGENSCHAFTEN TASCHE · FEATURES BAG/ CARACTÉRISTIQUES DU SAC
 36
 34
 22
 cm
 45
 cm
 45
 cm
 1,9
 kg
 2,5
 kg
 40
 kg

EIGENSCHAFTEN FAHRGESTELL · FEATURES FRAME/ CARACTÉRISTIQUES DU CHÂSSIS
 101
 cm
 101
 cm
 1,9
 kg
 2,5
 kg
 40
 kg



GRÜN/GREEN/VERT · ART.-NR.: 112-133-50

EIGENSCHAFTEN TASCHE · FEATURES BAG/ CARACTÉRISTIQUES DU SAC
 EIGENSCHAFTEN FAHRGESTELL · FEATURES FRAME/ CARACTÉRISTIQUES DU CHÂSSIS



SCHWARZ/BLACK/NOIR
 ART.-NR.: 112-133-80



TÜRKIS/TURQUOIS/TURQUOISE
 ART.-NR.: 112-133-90

ROT/RED/ROUGE · ART.-NR.: 112-133-70



ROT/RED/ROUGE · ART.-NR.: 112-108-70

EIGENSCHAFTEN TASCHE · FEATURES BAG/ CARACTÉRISTIQUES DU SAC
 EIGENSCHAFTEN FAHRGESTELL · FEATURES FRAME/ CARACTÉRISTIQUES DU CHÂSSIS



BLAU/BLUE/BLEU · ART.-NR.: 112-108-90



WEISS/WHITE/BLANC · ART.-NR.: 112-124-00

EIGENSCHAFTEN TASCHE · FEATURES BAG/ CARACTÉRISTIQUES DU SAC
 EIGENSCHAFTEN FAHRGESTELL · FEATURES FRAME/ CARACTÉRISTIQUES DU CHÂSSIS



SCHWARZ/BLACK/NOIR · ART.-NR.: 112-124-80

SCALA SHOPPER® MUNA



WEISS/WHITE/BLANC · ART.-NR.: 112-123-00

EIGENSCHAFTEN TASCHЕ · FEATURES BAG/ CARACTÉRISTIQUES DU SAC



EIGENSCHAFTEN FAHRGESTELL · FEATURES FRAME/ CARACTÉRISTIQUES DU CHÂSSIS



SCHWARZ/BLACK/NOIR · ART.-NR.: 112-123-80



SCALA SHOPPER® KIRA



SILBER/SILVER/ARGENT · ART.-NR.: 112-136-20

EIGENSCHAFTEN TASCHЕ · FEATURES BAG/ CARACTÉRISTIQUES DU SAC



EIGENSCHAFTEN FAHRGESTELL · FEATURES FRAME/ CARACTÉRISTIQUES DU CHÂSSIS



ROT/RED/ROUGE · ART.-NR.: 112-136-70



GRAU/GREY/GRIS
ART.-NR.: 112-136-80



BLAU/BLUE/BLEU
ART.-NR.: 112-136-90



SCALA SHOPPER® ALBA



ROT/RED/ROUGE · ART.-NR.: 112-138-70

EIGENSCHAFTEN TASCHЕ · FEATURES BAG/ CARACTÉRISTIQUES DU SAC



EIGENSCHAFTEN FAHRGESTELL · FEATURES FRAME/ CARACTÉRISTIQUES DU CHÂSSIS



SCHWARZ/BLACK/NOIR · ART.-NR.: 112-138-80





Scala PLUS
SHOPPER®
ALUMINIUM

FEATURES...

Mit KistenFix
With KistenFix
Incl. KistenFix



Seitlich unbegrenzt
No limit sideways
Tout gabarit de charge possible



VIDEO



SCALA SHOPPER® PLUS BEA



GRAU/GREY/GRIS · ART.-NR.: 133-139-20

- EIGENSCHAFTEN TASCHE · FEATURES BAG/ CARACTÉRISTIQUES DU SAC
- 36
 - 54
 - 22 cm
 - 34
 - 15 cm
 - 103 cm
 - 1,4 kg
 - 2,0 kg
 - 30 kg
- EIGENSCHAFTEN FAHRGESTELL · FEATURES FRAME/ CARACTÉRISTIQUES DU CHÂSSIS
- alu
 - 39 cm
 - 15 cm
 - 103 cm
 - 1,4 kg
 - 2,0 kg
 - 30 kg



ROT/RED/ROUGE · ART.-NR.: 133-139-70

SCALA SHOPPER® PLUS LINI



ROT/RED/ROUGE · ART.-NR.: 133-108-70

- EIGENSCHAFTEN TASCHE · FEATURES BAG/ CARACTÉRISTIQUES DU SAC
- 34
 - 35
 - 48
 - 22 cm
 - 34
 - 15 cm
 - 103 cm
 - 1,4 kg
 - 2,1 kg
 - 30 kg
- EIGENSCHAFTEN FAHRGESTELL · FEATURES FRAME/ CARACTÉRISTIQUES DU CHÂSSIS
- alu
 - 39 cm
 - 15 cm
 - 103 cm
 - 1,4 kg
 - 2,1 kg
 - 30 kg



BLAU/BLUE/BLEU · ART.-NR.: 133-108-90

SCALA SHOPPER® PLUS MUNA



WEISS/WHITE/BLANC · ART.-NR.: 133-123-00

- EIGENSCHAFTEN TASCHE · FEATURES BAG/ CARACTÉRISTIQUES DU SAC
- 34
 - 35
 - 48
 - 22 cm
 - 34
 - 15 cm
 - 103 cm
 - 1,4 kg
 - 2,2 kg
 - 30 kg
- EIGENSCHAFTEN FAHRGESTELL · FEATURES FRAME/ CARACTÉRISTIQUES DU CHÂSSIS
- alu
 - 39 cm
 - 15 cm
 - 103 cm
 - 1,4 kg
 - 2,2 kg
 - 30 kg



SCHWARZ/BLACK/NOIR · ART.-NR.: 133-123-80



THERMOFACH INNEN
INSULATED BAG INSIDE
POCHE INTÉRIEURE ISOTHERME



GRAU/GREY/GRIS · ART.-NR.: 133-130-20

EIGENSCHAFTEN TASCHE · FEATURES BAG/ CARACTÉRISTIQUES DU SAC



EIGENSCHAFTEN FAHRGESTELL · FEATURES FRAME/ CARACTÉRISTIQUES DU CHÂSSIS



GOLD/GOLD/OR · ART.-NR.: 133-128-00

EIGENSCHAFTEN TASCHE · FEATURES BAG/ CARACTÉRISTIQUES DU SAC



EIGENSCHAFTEN FAHRGESTELL · FEATURES FRAME/ CARACTÉRISTIQUES DU CHÂSSIS



GRÜN/GREEN/VERT · ART.-NR.: 133-135-50



BLAU/BLEU · ART.-NR.: 133-130-90



SCHWARZ/BLACK/NOIR · ART.-NR.: 133-128-80



SCHWARZ/BLACK/NOIR · ART.-NR.: 133-135-80



ROT/RED/ROUGE · ART.-NR.: 133-135-70

- EIGENSCHAFTEN TASCHE · FEATURES BAG/ CARACTÉRISTIQUES DU SAC
- 36 cm
 - 58 cm
 - 22 cm
 - 43 cm
 - 39 cm
 - 15 cm
 - 103 cm
 - 1,4 kg
 - 2,3 kg
 - 30 kg
- EIGENSCHAFTEN FAHRGESTELL · FEATURES FRAME/ CARACTÉRISTIQUES DU CHÂSSIS
- alu
 - 39 cm
 - 15 cm
 - 103 cm
 - 1,4 kg
 - 2,3 kg
 - 30 kg



THERMOFACH INNEN
INSULATED BAG INSIDE
POCHE INTÉRIEURE ISOTHERME

TÜRKIS/TURQUOIS/TURQUOISE · ART.-NR.: 133-135-90



ROT/RED/ROUGE · ART.-NR.: 133-137-70

- EIGENSCHAFTEN TASCHE · FEATURES BAG/ CARACTÉRISTIQUES DU SAC
- 35 cm
 - 58 cm
 - 22 cm
 - 39 cm
 - 15 cm
 - 103 cm
 - 1,4 kg
 - 2,1 kg
 - 30 kg
- EIGENSCHAFTEN FAHRGESTELL · FEATURES FRAME/ CARACTÉRISTIQUES DU CHÂSSIS
- alu
 - 39 cm
 - 15 cm
 - 103 cm
 - 1,4 kg
 - 2,1 kg
 - 30 kg

SCHWARZ/BLACK/NOIR · ART.-NR.: 133-137-80



SCALA SHOPPER® PLUS SILA



SILBER/SILVER/ARGENT · ART.-NR.: 133-141-20

- EIGENSCHAFTEN TASCHE · FEATURES BAG/ CARACTÉRISTIQUES DU SAC
- 36 cm
 - 58 cm
 - 23 cm
 - 40 cm
 - 39 cm
 - 15 cm
 - 103 cm
 - 1,4 kg
 - 2,2 kg
 - 30 kg
- EIGENSCHAFTEN FAHRGESTELL · FEATURES FRAME/ CARACTÉRISTIQUES DU CHÂSSIS
- alu
 - 39 cm
 - 15 cm
 - 103 cm
 - 1,4 kg
 - 2,2 kg
 - 30 kg

GRAU/GREY/GRIS · ART.-NR.: 133-141-80





alustar
SHOPPER®
ALUMINIUM

FEATURES...

←27→
22-29
cm

Seitlich unbegrenzt
No limit sideways
Tout gabarit de
charge possible



VIDEO





SCHWARZ/BLACK/NOIR · ART.-NR.: 115-128-80



GOLD/GOLD/OR · ART.-NR.: 115-128-00

EIGENSCHAFTEN TASCHÉ · FEATURES BAG/ CARACTÉRISTIQUES DU SAC



EIGENSCHAFTEN FAHRGESTELL · FEATURES FRAME/ CARACTÉRISTIQUES DU CHÂSSIS



ALU STAR SHOPPER® HENNI



SCHWARZ/BLACK/NOIR · ART.-NR.: 115-125-80



WEISS/ WHITE/BLANC · ART.-NR.: 115-125-00

EIGENSCHAFTEN TASCHÉ · FEATURES BAG/ CARACTÉRISTIQUES DU SAC



EIGENSCHAFTEN FAHRGESTELL · FEATURES FRAME/ CARACTÉRISTIQUES DU CHÂSSIS



ALU STAR SHOPPER® HAVA



BLAU/BLUE/BLEU · ART.-NR.: 115-103-92



SILBER/SILVER/ARGENT · ART.-NR.: 115-103-22

EIGENSCHAFTEN TASCHÉ · FEATURES BAG/ CARACTÉRISTIQUES DU SAC



EIGENSCHAFTEN FAHRGESTELL · FEATURES FRAME/ CARACTÉRISTIQUES DU CHÂSSIS





SCHWARZ/BLACK/NOIR · ART.-NR.: 115-132-80

EIGENSCHAFTEN TASCHE · FEATURES BAG/ CARACTÉRISTIQUES DU SAC



EIGENSCHAFTEN FAHRGESTELL · FEATURES FRAME/ CARACTÉRISTIQUES DU CHÂSSIS



GRÜN/GREEN/VERT · ART.-NR.: 115-036-50



ROT/RED/ROUGE · ART.-NR.: 115-036-70

EIGENSCHAFTEN TASCHE · FEATURES BAG/ CARACTÉRISTIQUES DU SAC



EIGENSCHAFTEN FAHRGESTELL · FEATURES FRAME/ CARACTÉRISTIQUES DU CHÂSSIS



BLAU/BLEU · ART.-NR.: 115-132-90



SCHWARZ/BLACK/NOIR · ART.-NR.: 115-036-80



TÜRKIS/TURQUOIS/TURQUOISE · ART.-NR. 115-036-90

ALS RUCKSACK VERWENDBAR
CAN BE USED AS RUCKSACK
UTILISABLE COMME SAC À DOS



THERMOFACH INNEN
INSULATED BAG INSIDE
POCHE INTÉRIEURE ISOTHERME





**QUATTRO
SHOPPER®**

FEATURES...



Seitlich unbegrenzt
No limit sideways
Tout gabarit de
charge possible



VIDEO



QUATTRO SHOPPER® VARA



WEISS/WHITE/BLANC · ART.-NR.: 185-124-00

EIGENSCHAFTEN TASCHE · FEATURES BAG/ CARACTÉRISTIQUES DU SAC



EIGENSCHAFTEN FAHRGESTELL · FEATURES FRAME/ CARACTÉRISTIQUES DU CHÂSSIS



SCHWARZ/BLACK/NOIR · ART.-NR.: 185-124-80

QUATTRO SHOPPER® LOME



GRAU/GREY/GRIS · ART.-NR.: 185-126-20

EIGENSCHAFTEN TASCHE · FEATURES BAG/ CARACTÉRISTIQUES DU SAC



EIGENSCHAFTEN FAHRGESTELL · FEATURES FRAME/ CARACTÉRISTIQUES DU CHÂSSIS



SCHWARZ/BLACK/NOIR · ART.-NR.: 185-126-80

QUATTRO SHOPPER® HENNI



WEISS/WHITE/BLANC · ART.-NR.: 185-125-00

EIGENSCHAFTEN TASCHE · FEATURES BAG/ CARACTÉRISTIQUES DU SAC



EIGENSCHAFTEN FAHRGESTELL · FEATURES FRAME/ CARACTÉRISTIQUES DU CHÂSSIS



SCHWARZ/BLACK/NOIR · ART.-NR.: 185-125-80

QUATTRO SHOPPER® ALBA



ROT/RED/ROUGE · ART.-NR.: 185-138-70

EIGENSCHAFTEN TASCHE · FEATURES BAG/ CARACTÉRISTIQUES DU SAC



EIGENSCHAFTEN FAHRGESTELL · FEATURES FRAME/ CARACTÉRISTIQUES DU CHÂSSIS



QUATTRO SHOPPER® SILA



SILBER/SILVER/ARGENT · ART.-NR.: 185-141-20

EIGENSCHAFTEN TASCHE · FEATURES BAG/ CARACTÉRISTIQUES DU SAC



EIGENSCHAFTEN FAHRGESTELL · FEATURES FRAME/ CARACTÉRISTIQUES DU CHÂSSIS



QUATTRO SHOPPER® MIMI



GOLD/GOLD/OR · ART.-NR.: 185-129-00

EIGENSCHAFTEN TASCHE · FEATURES BAG/ CARACTÉRISTIQUES DU SAC



EIGENSCHAFTEN FAHRGESTELL · FEATURES FRAME/ CARACTÉRISTIQUES DU CHÂSSIS



SCHWARZ/BLACK/NOIR · ART.-NR.: 185-138-80



THERMOFACH INNEN
INSULATED BAG INSIDE
POCHE INTÉRIEURE ISOTHERME



GRAU/GREY/GRIS · ART.-NR.: 185-141-80



THERMOFACH INNEN
INSULATED BAG INSIDE
POCHE INTÉRIEURE ISOTHERME



SCHWARZ/BLACK/NOIR · ART.-NR.: 185-129-80

ROYAL SHOPPER® ALUMINIUM



FEATURES...

Als Fahrradanhänger einsetzbar
Can also be fitted to a bicycle
Utilisable comme remorque de vélo

siehe Seite/see page/voir page:
82-86



SIEBEN verschiedene Räder
SEVEN different wheels
SEPT roues différentes



Mit HängFix
With HängFix
Incl. HängFix



35
23-33
cm

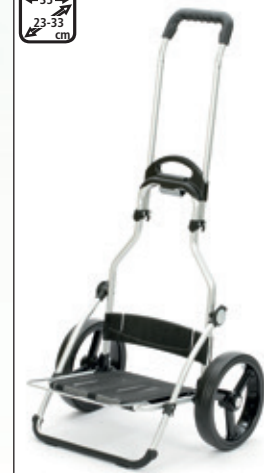

VIDEO



ROYAL SHOPPER® HERA



SILBER/SILVER/ARGENT · ART.-NR.: 166-004-22



GRAU/GREY/GRIS · ART.-NR.: 166-004-82



ROT/RED/ROUGE · ART.-NR.: 166-004-72



BLAU/BLUE/BLEU · ART.-NR.: 166-004-92

EIGENSCHAFTEN TASCHE · FEATURES BAG/ CARACTÉRISTIQUES DU SAC



EIGENSCHAFTEN FAHRGESTELL · FEATURES FRAME/ CARACTÉRISTIQUES DU CHÂSSIS



ROYAL SHOPPER® EDA



SCHWARZ/BLACK/NOIR · ART.-NR.: 166-134-80



TÜRKIS/TURQUOIS/TURQUOISE · ART.-NR.: 166-134-90

EIGENSCHAFTEN TASCHE · FEATURES BAG/ CARACTÉRISTIQUES DU SAC



EIGENSCHAFTEN FAHRGESTELL · FEATURES FRAME/ CARACTÉRISTIQUES DU CHÂSSIS



ROYAL SHOPPER® PEPE



SILBER/SILVER/ARGENT · ART.-NR.: 166-050-22



TÜRKIS/TURQUOIS/TURQUOISE · ART.-NR.: 166-050-52



FLIEDER/LILAC/LILAS · ART.-NR.: 166-050-62



ROT/RED/ROUGE · ART.-NR.: 166-050-72



GRAU/GREY/GRIS · ART.-NR.: 166-050-82



BLAU/BLUE/BLEU · ART.-NR.: 166-050-92

- EIGENSCHAFTEN TASCHÉ · FEATURES BAG/ CARACTÉRISTIQUES DU SAC
- 39
 - 58
 - 35
 - 22 cm
 - 39
 - 58
 - 35
 - 22 cm
 - 39
 - 58
 - 35
 - 22 cm
- EIGENSCHAFTEN FAHRGESTELL · FEATURES FRAME/ CARACTÉRISTIQUES DU CHÂSSIS
- 107 cm
 - 25 kg
 - 2,5 kg
 - 3,2 kg
 - 50 kg

ROYAL SHOPPER® TILLY



GRÜN/GREEN/VERT · ART.-NR.: 166-135-50

EIGENSCHAFTEN TASCHE · FEATURES BAG/ CARACTÉRISTIQUES DU SAC



EIGENSCHAFTEN FAHRGESTELL · FEATURES FRAME/ CARACTÉRISTIQUES DU CHÂSSIS



SCHWARZ/BLACK/NOIR
ART.-NR.: 166-135-80



TÜRKIS/TURQUOIS/TURQUOISE
ART.-NR.: 166-135-90

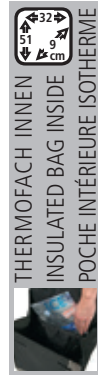

THERMOFACH INNEN
INSULATED BAG INSIDE
POCHE INTÉRIEURE ISOTHERME

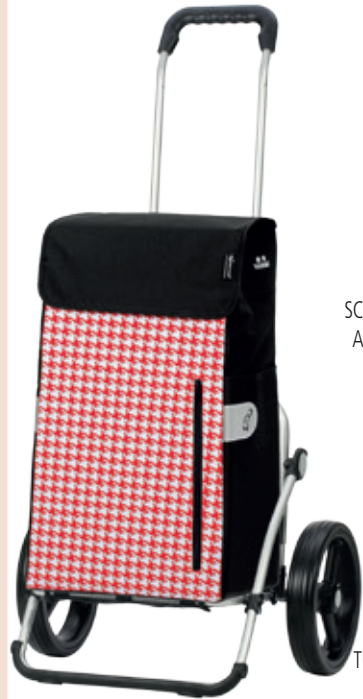

ROT/RED/ROUGE · ART.-NR.: 166-135-70

ROYAL SHOPPER® MEER



SCHWARZ/BLACK/NOIR · ART.-NR.: 166-132-80

EIGENSCHAFTEN TASCHE · FEATURES BAG/ CARACTÉRISTIQUES DU SAC



EIGENSCHAFTEN FAHRGESTELL · FEATURES FRAME/ CARACTÉRISTIQUES DU CHÂSSIS



BLAU/BLUE/BLEU · ART.-NR.: 166-132-90

ROYAL SHOPPER® KIRA



SILBER/SILVER/ARGENT · ART.-NR.: 166-136-20

EIGENSCHAFTEN TASCHE · FEATURES BAG/ CARACTÉRISTIQUES DU SAC



EIGENSCHAFTEN FAHRGESTELL · FEATURES FRAME/ CARACTÉRISTIQUES DU CHÂSSIS



GRAU/GREY/GRIS
ART.-NR.: 166-136-80



BLAU/BLUE/BLEU
ART.-NR.: 166-136-90



THERMOFACH INNEN
INSULATED BAG INSIDE
POCHE INTÉRIEURE ISOTHERME



ROT/RED/ROUGE · ART.-NR.: 166-136-70

ROYAL SHOPPER® ALBA



ROT/RED/ROUGE · ART.-NR.: 166-138-70



SCHWARZ/BLACK/NOIR · ART.-NR.: 166-138-80

EIGENSCHAFTEN TASCHЕ · FEATURES BAG/ CARACTÉRISTIQUES DU SAC



THERMOFACH INNEN
INSULATED BAG INSIDE
POCHE INTÉRIEURE ISOTHERME



ROYAL SHOPPER® SILA



SILBER/SILVER/ARGENT · ART.-NR.: 166-141-20



GRAU/GREY/GRIS · ART.-NR.: 166-141-80

EIGENSCHAFTEN TASCHЕ · FEATURES BAG/ CARACTÉRISTIQUES DU SAC



EIGENSCHAFTEN FAHRGESTELL · FEATURES FRAME/ CARACTÉRISTIQUES DU CHÂSSIS



ROYAL SHOPPER® ORTLIEB



SILBER/SILVER/ARGENT · ART.-NR.: 166-082-21



LIMONE/LIME/LIMON · ART.-NR.: 166-082-51

TASCHЕ / BAG / SAC
MADE BY
ORTLIEB
WATERPROOF

EIGENSCHAFTEN TASCHЕ · FEATURES BAG/ CARACTÉRISTIQUES DU SAC



EIGENSCHAFTEN FAHRGESTELL · FEATURES FRAME/ CARACTÉRISTIQUES DU CHÂSSIS



ROT/RED/ROUGE
ART.-NR.: 166-082-71



SCHWARZ/BLACK/NOIR
ART.-NR.: 166-082-81

ROYAL SHOPPER® VARA



WEISS/WHITE/BLANC · ART.-NR.: 168-124-00



SCHWARZ/BLACK/NOIR · ART.-NR.: 168-124-80

EIGENSCHAFTEN TASCHE · FEATURES BAG/ CARACTÉRISTIQUES DU SAC



EIGENSCHAFTEN FAHRGESTELL · FEATURES FRAME/ CARACTÉRISTIQUES DU CHÂSSIS



ROYAL SHOPPER® HENNI



WEISS/WHITE/BLANC · ART.-NR.: 168-125-00



SCHWARZ/BLACK/NOIR · ART.-NR.: 168-125-80

EIGENSCHAFTEN TASCHE · FEATURES BAG/ CARACTÉRISTIQUES DU SAC



EIGENSCHAFTEN FAHRGESTELL · FEATURES FRAME/ CARACTÉRISTIQUES DU CHÂSSIS



ROYAL SHOPPER® SENTA



WEISS/WHITE/BLANC · ART.-NR.: 168-028-00



SCHWARZ/BLACK/NOIR · ART.-NR.: 168-028-80

EIGENSCHAFTEN TASCHE · FEATURES BAG/ CARACTÉRISTIQUES DU SAC



EIGENSCHAFTEN FAHRGESTELL · FEATURES FRAME/ CARACTÉRISTIQUES DU CHÂSSIS



ROYAL SHOPPER® TILLY



GRÜN/GREEN/VERT · ART.-NR.: 168-135-50

- EIGENSCHAFTEN TASCHE · FEATURES BAG/ CARACTÉRISTIQUES DU SAC
- 32
 - 36
 - 43
 - 48
 - 58
 - 23 cm
 - 26 kg
 - 35 kg
 - 50 kg
- EIGENSCHAFTEN FAHRGESTELL · FEATURES FRAME/ CARACTÉRISTIQUES DU CHÂSSIS
- 107
 - 45
 - 26 kg
 - 36 kg
 - 50 kg

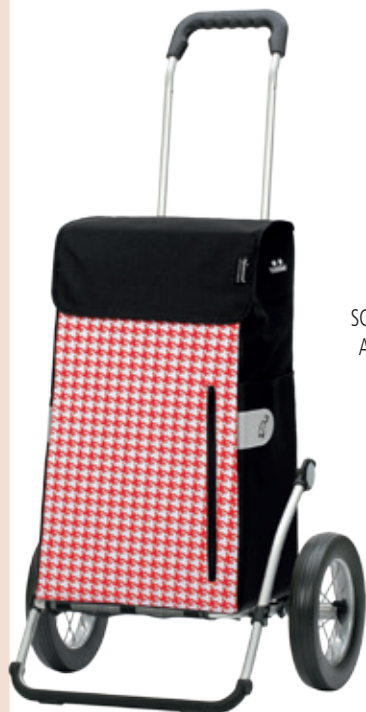

ROT/RED/ROUGE · ART.-NR.: 168-135-70

SCHWARZ/BLACK/NOIR
ART.-NR.: 168-135-80



TÜRKIS/TURQUOIS/TURQUOISE
ART.-NR.: 168-135-90



THERMOFACH INNEN
INSULATED BAG INSIDE
POCHE INTÉRIEURE ISOTHERME

ROYAL SHOPPER® VIKA



WEISS/WHITE/BLANC · ART.-NR.: 168-107-00

- EIGENSCHAFTEN TASCHE · FEATURES BAG/ CARACTÉRISTIQUES DU SAC
- 36
 - 46
 - 57
 - 23 cm
 - 26 kg
 - 36 kg
 - 50 kg
- EIGENSCHAFTEN FAHRGESTELL · FEATURES FRAME/ CARACTÉRISTIQUES DU CHÂSSIS
- 107
 - 45
 - 26 kg
 - 36 kg
 - 50 kg



SCHWARZ/BLACK/NOIR · ART.-NR.: 168-107-80



THERMOFACH INNEN
INSULATED BAG INSIDE
POCHE INTÉRIEURE ISOTHERME

ROYAL SHOPPER® MIMI



GOLD/GOLD/OR · ART.-NR.: 168-129-00

- EIGENSCHAFTEN TASCHE · FEATURES BAG/ CARACTÉRISTIQUES DU SAC
- 32
 - 36
 - 48
 - 58
 - 22 cm
 - 26 kg
 - 36 kg
 - 50 kg
- EIGENSCHAFTEN FAHRGESTELL · FEATURES FRAME/ CARACTÉRISTIQUES DU CHÂSSIS
- 107
 - 45
 - 26 kg
 - 36 kg
 - 50 kg



SCHWARZ/BLACK/NOIR · ART.-NR.: 168-129-80



THERMOFACH INNEN
INSULATED BAG INSIDE
POCHE INTÉRIEURE ISOTHERME

SEVEN!

Seite/page/page 64-67

Seite/page/page 52-53

Seite/page/page 50-51

Seite/page/page 48-49

Seite/page/page 45-47

Seite/page/page 42-43

Seite/page/page 36-41



ROYAL
SHOPPER®
ALUMINIUM

Treppensteigerrad / triple wheel / couronne à trois roues

luftbereiftes Kugellagerad / pneumatic ball-bearing wheel
roue pneumatique à roulement à billes
Ø 29cm

Kugellagerad / ball-bearing wheel / roue à roulement à billes
Ø 29cm

luftbereiftes Kugellagerad / pneumatic ball-bearing wheel
roue pneumatique à roulement à billes
Ø 25cm

Kugellagerad / ball-bearing wheel / roue à roulement à billes
Ø 25cm

Metallspeichenrad / spoked metal wheel / roue à rayons métalliques
Ø 25cm

3-Speichenrad / 3-spoke wheel / roue à 3 rayons
Ø 25cm

ROYAL SHOPPER® LIZZY



ROT/RED/ROUGE · ART.-NR.: 167-140-70



BLAU/BLEU · ART.-NR.: 167-140-90

EIGENSCHAFTEN TASCHEN · FEATURES BAG / CARACTÉRISTIQUES DU SAC



EIGENSCHAFTEN FAHRGESTELL · FEATURES FRAME / CARACTÉRISTIQUES DU CHÂSSIS



ROYAL SHOPPER® HENNI

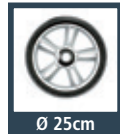

WEISS/WHITE/BLANC · ART.-NR.: 167-125-00



SCHWARZ/BLACK/NOIR · ART.-NR.: 167-125-80

EIGENSCHAFTEN TASCHEN · FEATURES BAG / CARACTÉRISTIQUES DU SAC



EIGENSCHAFTEN FAHRGESTELL · FEATURES FRAME / CARACTÉRISTIQUES DU CHÂSSIS



ROYAL SHOPPER® VIKA



WEISS/WHITE/BLANC · ART.-NR.: 167-107-00



SCHWARZ/BLACK/NOIR · ART.-NR.: 167-107-80

EIGENSCHAFTEN TASCHEN · FEATURES BAG / CARACTÉRISTIQUES DU SAC



EIGENSCHAFTEN FAHRGESTELL · FEATURES FRAME / CARACTÉRISTIQUES DU CHÂSSIS



ROYAL SHOPPER® LILO



ROT/RED/ROUGE · ART.-NR.: 167-137-70



SCHWARZ/BLACK/NOIR · ART.-NR.: 167-137-80



- EIGENSCHAFTEN TASCHE · FEATURES BAG/ CARACTÉRISTIQUES DU SAC
- 39
 - 58
 - 22
 - 35
- EIGENSCHAFTEN FAHRGESTELL · FEATURES FRAME/ CARACTÉRISTIQUES DU CHÂSSIS
- alu
 - 107
 - 2,6
 - 3,3
 - 50

ROYAL SHOPPER® KIRA



SILBER/SILVER/ARGENT · ART.-NR.: 167-136-20



ROT/RED/ROUGE · ART.-NR.: 167-136-70



- EIGENSCHAFTEN TASCHE · FEATURES BAG/ CARACTÉRISTIQUES DU SAC
- 41
 - 58
 - 22
 - 35
- EIGENSCHAFTEN FAHRGESTELL · FEATURES FRAME/ CARACTÉRISTIQUES DU CHÂSSIS
- alu
 - 107
 - 2,6
 - 3,5
 - 50



GRAU/GREY/GRIS
ART.-NR.: 167-136-80



BLAU/BLUE/BLEU
ART.-NR.: 167-136-90

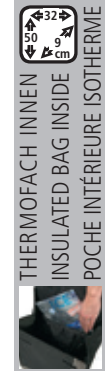

THERMOFACH INNEN
INSULATED BAG INSIDE
POCHE INTÉRIEURE ISOTHERME

ROYAL SHOPPER® SILA



SILBER/SILVER/ARGENT · ART.-NR.: 167-141-20



SCHWARZ/BLACK/NOIR · ART.-NR.: 167-141-80



- EIGENSCHAFTEN TASCHE · FEATURES BAG/ CARACTÉRISTIQUES DU SAC
- 40
 - 58
 - 23
 - 36
- EIGENSCHAFTEN FAHRGESTELL · FEATURES FRAME/ CARACTÉRISTIQUES DU CHÂSSIS
- alu
 - 107
 - 2,6
 - 3,4
 - 50

ROYAL SHOPPER® MEER

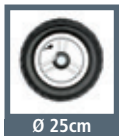

SCHWARZ/BLACK/NOIR · ART.-NR.: 163-132-80



BLAU/BLEU/BLEU · ART.-NR.: 163-132-90

EIGENSCHAFTEN TASCHEN · FEATURES BAG / CARACTÉRISTIQUES DU SAC



EIGENSCHAFTEN FAHRGESTELL · FEATURES FRAME / CARACTÉRISTIQUES DU CHÂSSIS



ROYAL SHOPPER® KIRA

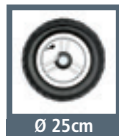

SILBER/SILVER/ARGENT · ART.-NR.: 163-136-20



ROT/RED/ROUGE · ART.-NR.: 163-136-70

EIGENSCHAFTEN TASCHEN · FEATURES BAG / CARACTÉRISTIQUES DU SAC



THERMOFACH INNEN
INSULATED BAG INSIDE
POCHE INTÉRIEURE ISOTHERME

GRAU/GREY/GRIS
ART.-NR.: 163-136-80

BLAU/BLEU/BLEU
ART.-NR.: 163-136-90

ROYAL SHOPPER® SILA



SILBER/SILVER/ARGENT · ART.-NR.: 163-141-20



GRAU/GREY/GRIS · ART.-NR.: 163-141-80

EIGENSCHAFTEN TASCHEN · FEATURES BAG / CARACTÉRISTIQUES DU SAC



EIGENSCHAFTEN FAHRGESTELL · FEATURES FRAME / CARACTÉRISTIQUES DU CHÂSSIS



ROYAL SHOPPER® MIMI



GOLD/GOLD/OR · ART.-NR.: 163-129-00

EIGENSCHAFTEN TASCHE · FEATURES BAG/ CARACTÉRISTIQUES DU SAC



THERMOFACH INNEN
INSULATED BAG INSIDE
POCHE INTÉRIEURE ISOTHERME



SCHWARZ/BLACK/NOIR · ART.-NR.: 163-129-80

ROYAL SHOPPER® HYDRO

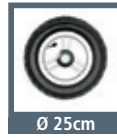

GRÜN/GREEN/VERT · ART.-NR.: 163-036-50

EIGENSCHAFTEN TASCHE · FEATURES BAG/ CARACTÉRISTIQUES DU SAC



THERMOFACH INNEN
INSULATED BAG INSIDE
POCHE INTÉRIEURE ISOTHERME



ROT/RED/ROUGE · ART.-NR.: 163-036-70

TÜRKIS/TURQUOIS/TURQUOISE
ART.-NR.: 163-036-90



SCHWARZ/BLACK/NOIR
ART.-NR.: 163-036-80



ROYAL SHOPPER® ORTLIEB



SILBER/SILVER/ARGENT · ART.-NR.: 163-082-21

TASCHE / BAG / SAC
MADE BY
ORTLIEB
WATERPROOF

EIGENSCHAFTEN TASCHE · FEATURES BAG/ CARACTÉRISTIQUES DU SAC



LIMONE/LIME/LIMON · ART.-NR.: 163-082-51



ROT/RED/ROUGE
ART.-NR.: 163-082-71



SCHWARZ/BLACK/NOIR
ART.-NR.: 163-082-81

ROYAL SHOPPER® LOME



GRAU/GREY/GRIS · ART.-NR.: 164-126-20



SCHWARZ/BLACK/NOIR · ART.-NR.: 164-126-80



EIGENSCHAFTEN TASCHEN · FEATURES BAG / CARACTÉRISTIQUES DU SAC



EIGENSCHAFTEN FAHRGESTELL · FEATURES FRAME / CARACTÉRISTIQUES DU CHÂSSIS



ROYAL SHOPPER® KIRA



SILBER/SILVER/ARGENT · ART.-NR.: 164-136-20



ROT/RED/ROUGE · ART.-NR.: 164-136-70



EIGENSCHAFTEN TASCHEN · FEATURES BAG / CARACTÉRISTIQUES DU SAC



THERMOFACH INNEN
INSULATED BAG INSIDE
POCHE INTÉRIEURE ISOTHERME

GRAU/GREY/GRIS
ART.-NR.: 164-136-80

BLAU/BLUE/BLEU
ART.-NR.: 164-136-90



ROYAL SHOPPER® HYDRO



GRÜN/GREEN/VERT · ART.-NR.: 164-036-50



SCHWARZ/BLACK/NOIR · ART.-NR.: 164-036-80



ROYAL PLUS
SHOPPER®
ALUMINIUM



FEATURES...

Als Fahrradanhänger einsetzbar
Can also be fitted to a bicycle
Utilisable comme remorque de vélo

siehe Seite/see page/voir page:
82-86



Mit HängFix
With HängFix
Incl. HängFix



Kugellagerad
ball-bearing wheel
roue à roulement à billes
Ø25cm



luftbereiftes Kugellagerad
pneumatic ball-bearing wheel
roue pneumatique à roulement à billes · Ø25cm

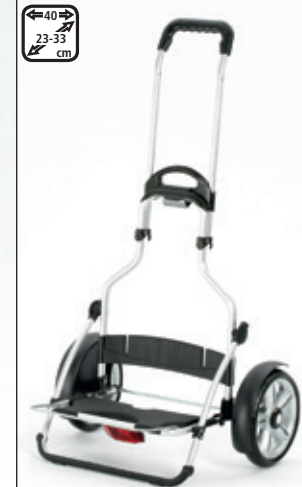

VIDEO



ROYAL SHOPPER® PLUS CLINT



GRÜN/GREEN/VERT · ART.-NR.: 147-142-50



ROT/RED/ROUGE · ART.-NR.: 147-142-70



EIGENSCHAFTEN TASCHE · FEATURES BAG/ CARACTÉRISTIQUES DU SAC



EIGENSCHAFTEN FAHRGESTELL · FEATURES FRAME/ CARACTÉRISTIQUES DU CHÂSSIS



ROYAL SHOPPER® PLUS HYDRO



GRÜN/GREEN/VERT · ART.-NR.: 147-036-50



ROT/RED/ROUGE · ART.-NR.: 147-036-70



EIGENSCHAFTEN TASCHE · FEATURES BAG/ CARACTÉRISTIQUES DU SAC



EIGENSCHAFTEN FAHRGESTELL · FEATURES FRAME/ CARACTÉRISTIQUES DU CHÂSSIS



ROYAL SHOPPER® PLUS FADO



GRÜN/GREEN/VERT · ART.-NR.: 147-143-50



ROT/RED/ROUGE · ART.-NR.: 147-143-70



EIGENSCHAFTEN TASCHE · FEATURES BAG/ CARACTÉRISTIQUES DU SAC



EIGENSCHAFTEN FAHRGESTELL · FEATURES FRAME/ CARACTÉRISTIQUES DU CHÂSSIS



SCHWARZ/BLACK/NOIR
ART.-NR.: 147-036-80



TÜRKIS/TURQUOIS/TURQUOISE
ART.-NR.: 147-036-90

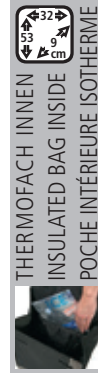

THERMOFACH INNEN
INSULATED BAG INSIDE
POCHE INTÉRIEURE ISOTHERME



THERMOFACH INNEN
INSULATED BAG INSIDE
POCHE INTÉRIEURE ISOTHERME

ROYAL SHOPPER® PLUS CLINT



GRÜN/GREEN/VERT · ART.-NR.: 143-142-50



ROT/RED/ROUGE · ART.-NR.: 143-142-70

EIGENSCHAFTEN TASCHEN · FEATURES BAG / CARACTÉRISTIQUES DU SAC



EIGENSCHAFTEN FAHRGESTELL · FEATURES FRAME / CARACTÉRISTIQUES DU CHÂSSIS



ROYAL SHOPPER® PLUS HYDRO



GRÜN/GREEN/VERT · ART.-NR.: 143-036-50



SCHWARZ/BLACK/NOIR · ART.-NR.: 143-036-80



ROT/RED/ROUGE · ART.-NR.: 143-036-70



TÜRKIS/TURQUOIS/TURQUOISE · ART.-NR.: 143-036-90

EIGENSCHAFTEN TASCHEN · FEATURES BAG / CARACTÉRISTIQUES DU SAC



EIGENSCHAFTEN FAHRGESTELL · FEATURES FRAME / CARACTÉRISTIQUES DU CHÂSSIS



ALS RUCKSACK VERWENDBAR
CAN BE USED AS RUCKSACK
UTILISABLE COMME SAC À DOS



THERMOFACH INNEN
INSULATED BAG INSIDE
POCHE INTÉRIEURE ISOTHERME





FEATURES...

Als Fahrradanhänger einsetzbar
 Can also be fitted to a bicycle
 Utilisable comme remorque
 de vélo

siehe Seite/see page
 voir page: 82-86



← 35 →
 ↙ 23-33 ↘
 cm

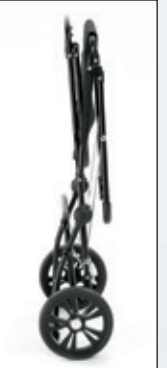



WEISS/WHITE/BLANC · ART.-NR.: 198-125-00

EIGENSCHAFTEN TASCHEN · FEATURES BAG/ CARACTÉRISTIQUES DU SAC



EIGENSCHAFTEN FAHRGESTELL · FEATURES FRAME/ CARACTÉRISTIQUES DU CHÂSSIS



SCHWARZ/BLACK/NOIR · ART.-NR.: 198-125-80



GRÜN/GREEN/VERT · ART.-NR.: 198-135-50

EIGENSCHAFTEN TASCHEN · FEATURES BAG/ CARACTÉRISTIQUES DU SAC



EIGENSCHAFTEN FAHRGESTELL · FEATURES FRAME/ CARACTÉRISTIQUES DU CHÂSSIS



ROT/RED/ROUGE · ART.-NR.: 198-135-70



TÜRKIS/TURQUOIS/TURQUOISE
ART.-NR.: 198-135-90



GOLD/GOLD/OR · ART.-NR.: 198-129-00

EIGENSCHAFTEN TASCHEN · FEATURES BAG/ CARACTÉRISTIQUES DU SAC



EIGENSCHAFTEN FAHRGESTELL · FEATURES FRAME/ CARACTÉRISTIQUES DU CHÂSSIS



SCHWARZ/BLACK/NOIR · ART.-NR.: 198-129-80





Scala
SHOPPER
TREPPENSTEIGER

FEATURES...



VIDEO





SILBER/SILVER/ARGENT · ART.-NR.: 119-004-22



ROT/RED/ROUGE · ART.-NR.: 119-004-72

EIGENSCHAFTEN TASCHЕ · FEATURES BAG/ CARACTÉRISTIQUES DU SAC



EIGENSCHAFTEN FAHRGESTELL · FEATURES FRAME/ CARACTÉRISTIQUES DU CHÂSSIS



GRAU/GREY/GRIS · ART.-NR.: 119-004-82



BLAU/BLUE/BLEU · ART.-NR.: 119-004-92



WEISS/WHITE/BLANC · ART.-NR.: 119-124-00

EIGENSCHAFTEN TASCHЕ · FEATURES BAG/ CARACTÉRISTIQUES DU SAC



EIGENSCHAFTEN FAHRGESTELL · FEATURES FRAME/ CARACTÉRISTIQUES DU CHÂSSIS



SCHWARZ/BLACK/NOIR · ART.-NR.: 119-124-80

TREPPENSTEIGER SCALA SHOPPER® VIKA



WEISS/WHITE/BLANC · ART.-NR.: 119-107-00

EIGENSCHAFTEN TASCHE · FEATURES BAG/ CARACTÉRISTIQUES DU SAC

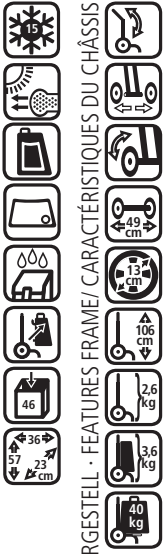

EIGENSCHAFTEN FAHRGESTELL · FEATURES FRAME/ CARACTÉRISTIQUES DU CHÂSSIS



SCHWARZ/BLACK/NOIR · ART.-NR.: 119-107-80



THERMOFACH INNEN
INSULATED BAG INSIDE
POCHE INTÉRIEURE ISOTHERME

TREPPENSTEIGER SCALA SHOPPER® LILO



ROT/RED/ROUGE · ART.-NR.: 119-137-70

EIGENSCHAFTEN TASCHE · FEATURES BAG/ CARACTÉRISTIQUES DU SAC



EIGENSCHAFTEN FAHRGESTELL · FEATURES FRAME/ CARACTÉRISTIQUES DU CHÂSSIS



SCHWARZ/BLACK/NOIR · ART.-NR.: 119-137-80

TREPPENSTEIGER SCALA SHOPPER® KIRA



SILBER/SILVER/ARGENT · ART.-NR.: 119-136-20

EIGENSCHAFTEN TASCHE · FEATURES BAG/ CARACTÉRISTIQUES DU SAC



EIGENSCHAFTEN FAHRGESTELL · FEATURES FRAME/ CARACTÉRISTIQUES DU CHÂSSIS



ROT/RED/ROUGE · ART.-NR.: 119-136-70



GRAU/GREY/GRIS
ART.-NR.: 119-136-80



BLAU/BLUE/BLEU
ART.-NR.: 119-136-90



THERMOFACH INNEN
INSULATED BAG INSIDE
POCHE INTÉRIEURE ISOTHERME

ROYAL
SHOPPER®
ALUMINIUM
TREPPENSTEIGER



FEATURES...

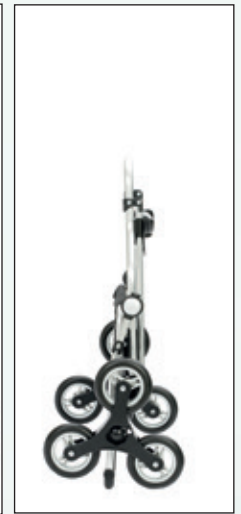
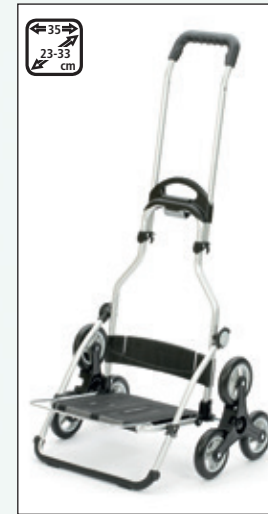

VIDEO



TREPPENSTEIGER ROYAL SHOPPER® IKO



GRÜN/GREEN/VERT · ART.-NR.: 169-133-50



SCHWARZ/BLACK/NOIR · ART.-NR.: 169-133-80



ROT/RED/ROUGE · ART.-NR.: 169-133-70



TÜRKIS/TURQUOIS/TURQUOISE · ART.-NR.: 169-133-90

EIGENSCHAFTEN TASCHEN · FEATURES BAG / CARACTÉRISTIQUES DU SAC



EIGENSCHAFTEN FAHRGESTELL · FEATURES FRAME / CARACTÉRISTIQUES DU CHÂSSIS



TREPPENSTEIGER ROYAL SHOPPER® HENNI



WEISS/WHITE/BLANC · ART.-NR.: 169-125-00



SCHWARZ/BLACK/NOIR · ART.-NR.: 169-125-80

EIGENSCHAFTEN TASCHEN · FEATURES BAG / CARACTÉRISTIQUES DU SAC



EIGENSCHAFTEN FAHRGESTELL · FEATURES FRAME / CARACTÉRISTIQUES DU CHÂSSIS



TREPPENSTEIGER ROYAL SHOPPER® SENTA



WEISS/WHITE/BLANC · ART.-NR.: 169-028-00



EIGENSCHAFTEN TASCHÉ · FEATURES BAG/ CARACTÉRISTIQUES DU SAC



EIGENSCHAFTEN FAHRGESTELL · FEATURES FRAME/ CARACTÉRISTIQUES DU CHÂSSIS

SCHWARZ/BLACK/NOIR · ART.-NR.: 169-028-80



TREPPENSTEIGER ROYAL SHOPPER® HAVA



SILBER/SILVER/ARGENT · ART.-NR.: 169-103-22



EIGENSCHAFTEN TASCHÉ · FEATURES BAG/ CARACTÉRISTIQUES DU SAC



EIGENSCHAFTEN FAHRGESTELL · FEATURES FRAME/ CARACTÉRISTIQUES DU CHÂSSIS

BLAU/BLUE/BLEU · ART.-NR.: 169-103-92



TREPPENSTEIGER ROYAL SHOPPER® KIRA



SILBER/SILVER/ARGENT · ART.-NR.: 169-136-20



EIGENSCHAFTEN TASCHÉ · FEATURES BAG/ CARACTÉRISTIQUES DU SAC



EIGENSCHAFTEN FAHRGESTELL · FEATURES FRAME/ CARACTÉRISTIQUES DU CHÂSSIS

ROT/RED/ROUGE · ART.-NR.: 169-136-70



GRAU/GREY/GRIS
ART.-NR.: 169-136-80



BLAU/BLUE/BLEU
ART.-NR.: 169-136-90

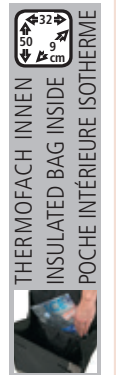

THERMOFACH INNEN
INSULATED BAG INSIDE
POCHE INTÉRIEURE ISOTHERME

KORB

Naturprodukt - Farbabweichungen möglich
Natural product - variation of colour possible
Matériau naturel - des teintes différentes sont donc possibles



KORB SHOPPER® NATURA

KORB SHOPPER®



NATURA CREME
OHNE STOFF / WITHOUT FABRIC / SANS TISSU
ART.-NR.: 9-650-20
MIT STOFF / WITH FABRIC / AVEC TISSU
ART.-NR.: 9-655-20



NATURA TERRA
OHNE STOFF / WITHOUT FABRIC / SANS TISSU
ART.-NR.: 9-650-40
MIT STOFF / WITH FABRIC / AVEC TISSU
ART.-NR.: 9-655-40

EIGENSCHAFTEN TASCHEN · FEATURES BAG / CARACTÉRISTIQUES DU SAC



EIGENSCHAFTEN FAHRGESTELL · FEATURES FRAME / CARACTÉRISTIQUES DU CHÂSSIS

NATURA XXL MIT STOFF / WITH
FABRIC / AVEC TISSU



KORB SHOPPER® NATURA XXL

**KORB
SHOPPER®**



NATURA XXL CREME
OHNE STOFF / WITHOUT FABRIC / SANS TISSU
ART.-NR.: 9-670-20
MIT STOFF / WITH FABRIC / AVEC TISSU
ART.-NR.: 9-675-20



NATURA XXL TERRA
OHNE STOFF / WITHOUT FABRIC / SANS TISSU
ART.-NR.: 9-670-40
MIT STOFF / WITH FABRIC / AVEC TISSU
ART.-NR.: 9-675-40

EIGENSCHAFTEN TASCHE · FEATURES BAG / CARACTÉRISTIQUES DU SAC



EIGENSCHAFTEN FAHRGESTELL · FEATURES FRAME / CARACTÉRISTIQUES DU CHÂSSIS

IPEK



Taschen komplett Thermo
Bags completely insulated
Sacs complètement isotherme

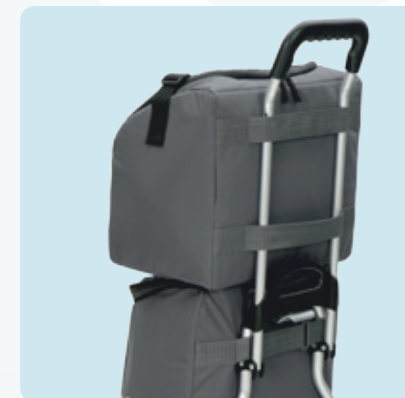

KÜHLBOX/THERMO BOX/GLACIÈRE BOX IPEK



EIGENSCHAFTEN TASCHЕ · FEATURES BAG · CARACTÉRISTIQUES DU SAC



SILBER/SILVER/ARGENT · ART.-NR.: 5-512-20

Scala
SHOPPER®

SCALA SHOPPER® IPEK



Taschen komplett Thermo
Bags completely insulated
Sacs complètement isotherme

EIGENSCHAFTEN TASCHЕ · FEATURES BAG/ CARACTÉRISTIQUES DU SAC

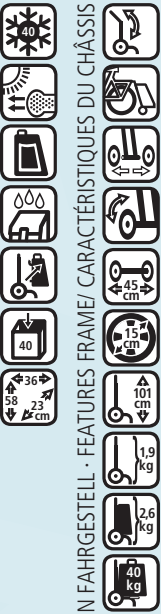

EIGENSCHAFTEN FAHRGESTELL · FEATURES FRAME/ CARACTÉRISTIQUES DU CHÂSSIS



SILBER/SILVER/ARGENT · ART.-NR.: 112-112-20

UNUS FUN
SHOPPER®
ALUMINIUM

UNUS SHOPPER® FUN IPEK



Taschen komplett Thermo
Bags completely insulated
Sacs complètement isotherme

EIGENSCHAFTEN TASCHЕ · FEATURES BAG/ CARACTÉRISTIQUES DU SAC



EIGENSCHAFTEN FAHRGESTELL · FEATURES FRAME/ CARACTÉRISTIQUES DU CHÂSSIS



SILBER/SILVER/ARGENT · ART.-NR.: 121-112-20

ROYAL
SHOPPER®
ALUMINIUM

ROYAL SHOPPER® IPEK



Taschen komplett Thermo
Bags completely insulated
Sacs complètement isotherme

EIGENSCHAFTEN TASCHЕ · FEATURES BAG/ CARACTÉRISTIQUES DU SAC



EIGENSCHAFTEN FAHRGESTELL · FEATURES FRAME/ CARACTÉRISTIQUES DU CHÂSSIS



SILBER/SILVER/ARGENT · ART.-NR.: 167-112-20

TRUCK PLANENTASCHEN

**JEDE TASCHE EIN UNIKAT
EVERY BAG IS UNIQUE
CHAQUE SAC EST UNIQUE**

Auf vielen Straßen Europas sind schwerbeladene LKW unterwegs. Die Planen sind das perfekte Material für Taschen: ungewöhnlich, strapazierfähig, robust und praktisch. Jede Tasche ist ein Unikat, denn sie wird aus original gefahrener LKW Plane von Hand in der Schweiz gefertigt.

You find trucks everywhere in Europe. Their tarpaulin covers provide the perfect material for bags : unusual, hard wearing and resistant. Every bag is unique, because it is handmade in Switzerland out of used truck tarpaulin.

Les camions promènent sur toutes les routes d'Europe leurs lourdes bâches colorées, matériau idéal pour les sacs car il est original, imperméable et ultra-résistant. Chaque sac est unique puisqu'il est fabriqué à la main en Suisse à partir de toiles de bâche recyclées.

UNUS SHOPPER® TRUCK A9



**JEDE TASCHE EIN UNIKAT
EVERY BAG IS UNIQUE
CHAQUE SAC EST UNIQUE**

**UNUS
SHOPPER®
ALUMINIUM**

EIGENSCHAFTEN TASCHSE · FEATURES BAG/ CARACTÉRISTIQUES DU SAC

-
-
-
-
-
-
-
-
-
-
-
-
-
-
-

UNUS SHOPPER® TRUCK A9 · ART.-NR.: 140-199-00

ROYAL SHOPPER® TRUCK A9



**JEDE TASCHE EIN UNIKAT
EVERY BAG IS UNIQUE
CHAQUE SAC EST UNIQUE**

**ROYAL
SHOPPER®
ALUMINIUM**

EIGENSCHAFTEN TASCHSE · FEATURES BAG/ CARACTÉRISTIQUES DU SAC

-
-
-
-
-
-
-
-
-
-
-
-
-
-
-

ROYAL SHOPPER® TRUCK A9 · ART.-NR.: 167-199-00

LUV & BOJE

100% recyceltes Segeltuch
100% recycled canvas · 100% de voiles de bateau recyclées

Handgemacht
Handmade · Fait à la main

Taschen aus Segeltuch

Die aus recycelten Segeln hergestellten 360° Segeltuchtaschen waren schon auf allen Weltmeeren unterwegs - bei Wind und Wetter, auf kleinen und auf großen Schiffen. Aufwändig verarbeitet und mit liebevollen Details versehen, starten sie ihr zweites Leben als super funktionale Taschen. Jede Tasche aus extrem belastbarem, wasserabweisendem Segeltuch ist ein einmaliges Unikat mit eingnähtem Herkunftsnachweis der Schiff und Reise nennt.

Sail canvas bags

The 360° bags consisting of recycled sails have been around on all oceans of the world- no matter if wind or storm, if small or tall boats. Very thoroughly and with lots of lovely details made, the bags now start their second life. Every bag of tough and water repellent sailcloth is unique and provides information about the boat and the trip once sailed on a little label inside.

Sacs fabriqués de voiles

Ces sacs fabriqués à partir de voiles de bateau recyclées ont fait le tour des océans par tous les temps sur tous les types de bateaux. Ils commencent à présent une seconde vie en beauté. Chaque sac en toile résistante et imperméable comporte une petite étiquette à l'intérieur qui renseigne sur l'origine et l'histoire de cette voile.



UNUS SHOPPER® FUN 360° LUV

UNUS FUN SHOPPER® ALUMINIUM



LUV12 · ART.-NR.: 121-090-12

LUV28 · ART.-NR.: 121-090-28

- EIGENSCHAFTEN TASCHE · FEATURES BAG / CARACTÉRISTIQUES DU SAC
- 40
 - 34
 - 35
 - 22
 - 22
 - cm
- EIGENSCHAFTEN FAHRGESTELL · FEATURES FRAME / CARACTÉRISTIQUES DU CHÂSSIS
- alu
 - 119
 - 119
 - cm
 - 1,6
 - kg
 - 2,4
 - kg
 - 40
 - kg

ROYAL SHOPPER® 360° LUV

ROYAL SHOPPER® ALUMINIUM



LUV12 · ART.-NR.: 164-090-12

LUV28 · ART.-NR.: 164-090-28

- EIGENSCHAFTEN TASCHE · FEATURES BAG / CARACTÉRISTIQUES DU SAC
- 40
 - 34
 - 35
 - 22
 - 22
 - cm
- EIGENSCHAFTEN FAHRGESTELL · FEATURES FRAME / CARACTÉRISTIQUES DU CHÂSSIS
- alu
 - 119
 - 119
 - cm
 - 1,6
 - kg
 - 2,4
 - kg
 - 40
 - kg
 - 2,9
 - kg
 - 3,7
 - kg
 - 50
 - kg

KUGELLAGERRAD / BALL-BEARING WHEEL / ROUE À ROULEMENT À BILLES · Ø 25CM

ROYAL SHOPPER® PLUS 360° BOJE

ROYAL PLUS
SHOPPER®
ALUMINIUM



BOJE 8 · ART.-NR.: 147-092-08

BOJE 9 · ART.-NR.: 147-092-09



KUGELLAGERRAD / BALL-BEARING WHEEL / ROUE À ROULEMENT À BILLES · Ø 29CM

TURA SHOPPER® 360° BOJE

TURA
SHOPPER®
ALUMINIUM



BOJE 8 · ART.-NR.: 135-092-08

BOJE 9 · ART.-NR.: 135-092-09

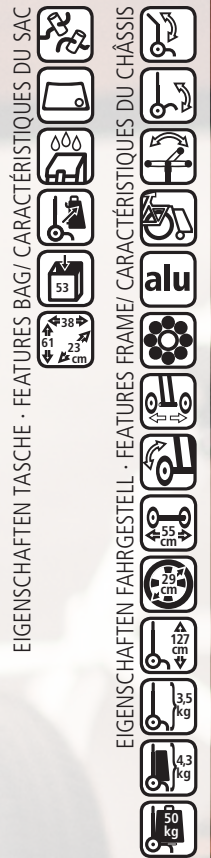

TURA SHOPPER® ORTLIEB

TASCHE / BAG / SAC
MADE BY
ORTLIEB

WATERPROOF



SILBER/SILVER/ARGENT · ART.-NR.:135-082-21

LIMONE/LIME/LIMON · ART.-NR.:135-082-51

ROT/RED/ROUGE · ART.-NR.:135-082-71

SCHWARZ/BLACK/NOIR · ART.-NR.:135-082-81

Tura
SHOPPER®
ALUMINIUM

- EIGENSCHAFTEN TASCHÉ · FEATURES BAG / CARACTÉRISTIQUES DU SAC
- EIGENSCHAFTEN FAHRGESTELL · FEATURES FRAME / CARACTÉRISTIQUES DU CHÂSSIS



KIDS

KIDS
SHOPPER®





Auch als Rucksack verwendbar
 Can be used as rucksack too
 Utilisable comme sac à dos



KIDS SHOPPER®

ROT/RED/ROUGE · ART.-NR.: 9-113-70

BLAU/BLUE/BLEU · ART.-NR.: 9-113-90

EIGENSCHAFTEN TASCHE · FEATURES BAG/ CARACTÉRISTIQUES DU SAC

- Icon: Backpack
- Icon: Mesh pocket
- Icon: Water-resistant
- Icon: Rain cover
- Icon: Keychain
- Icon: 24h
- Icon: 30 cm
- Icon: 13 cm

EIGENSCHAFTEN FAHRGESTELL · FEATURES FRAME/ CARACTÉRISTIQUES DU CHÂSSIS

- Icon: 3 wheels
- Icon: 25 cm
- Icon: 17 cm
- Icon: 70 cm
- Icon: 65 cm
- Icon: 1.0 kg
- Icon: 1.3 kg
- Icon: 20 kg

NEWSCHOOL



newschool
SHOPPER®
ALUMINIUM

FEATURES...



Als Fahrradanhänger einsetzbar
Can also be fitted to a bicycle
Utilisable comme remorque de vélo
siehe Seite/see page/voir page: 82-86

Inklusive 2 Aufkleber
Inclusive 2 stickers
Inclus 2 autocollants



VIDEO



VIDEO
GRIFF/GRIP
POIGNÉE



DER SCHULRANZEN IST MOBIL, DANK ANDERSEN!

Diese Generation des NewSchool Shopper® setzt neue Maßstäbe in Technik und Design durch coole Optik des ovalen Aluminiumrohrs und 3-Wege-System Griff kombiniert mit einfacher Bedienbarkeit.

Der 3-Wege-System Griff ermöglicht kindgerechte Handhabung des NewSchool Shopper® ohne die Handgelenke oder den Rücken zu verdrehen.

Durch die stufenlose Höheneinstellung der Teleskopstange mittels einer großen, gut zu bedienenden Einhandarretierung, variiert die Gesamthöhe zwischen 71 cm und 104 cm und wächst so mit. Eine Spurbreite von 49 cm und die stabile Konstruktion des Gestells sprechen für das kindgerechte Produkt, das sich schnell und einfach klein zusammenschieben lässt.

Die Flüsterräder mit einem Durchmesser von 15 cm meistern Hindernisse wie Bordsteine und Treppenstufen problemlos.

Der NewSchool Shopper® ist mit 40 cm Zwischenmaß für fast alle gängigen Schulranzen kompatibel.

Der Newschool Shopper® kann ans Fahrrad gekuppelt werden.
Für genauere Erklärungen zum 3-Wege-System Griff siehe VIDEO

THE SCHOOLBAG IS MOBILE, THANKS TO ANDERSEN!

This generation of the NewSchool Shopper® has been given a new futuristic look (its oval aluminium tube) and a better handling with a 3-way-system grip. This 3-way-system grip makes it easy for children to use without twisting their wrists or their backs.

The smooth telescopic height adjustment goes from 71 cm to 104 cm. The locker can be operated by one hand.

The wheel distance of 49 cm and the sturdy frame of this Shopper® make it safe and ideal for children's use. The wheels with a diameter of 15 cm run smoothly and silently and have no problem with kerbs and steps.

With its medium size (40 cm) this NewSchool Shopper® is suitable for most regular schoolbags.

The Newschool Shopper® can be connected to the bicycle.
For further information about the 3-way-system grip see VIDEO

LE CARTABLE BOUGE TOUT SEUL GRÂCE À ANDERSEN !

Cette génération du NewSchool Shopper® innove en matière de technicité et de style. Sa tubulure ovale en aluminium lui donne une allure futuriste et sa poignée à 3 positions facilite son utilisation.

Ce système à 3 positions permet aux enfants de le manier plus facilement sans se tordre le poignet ou le dos.

Le réglage en hauteur de 71 à 104 cm est simple et rapide et le verrouillage se fait d'une seule main.

L'empattement des roues de 49 cm et la robustesse du châssis en font un Shopper® destiné à l'utilisation des enfants. Les roues de 15 cm de diamètre roulent en douceur et en silence. Les bords de trottoirs et les marches d'escaliers ne posent aucun problème.

Le NewSchool Shopper® d'une taille moyenne de 40 cm est compatible avec la plupart des cartables courants.

Le Newschool Shopper® peut être accouplé au vélo depuis peu.
Pour plus de détails sur le système de poignée à 3 positions, voir VIDEO

Ovales
Aluminiumrohr
Oval aluminium tube
Tubulure ovale en
aluminium

3-Wege-System Griff
3-way-system grip
Poignée à 3 positions



Einhandarretierung
Locker by one hand
usable
Verrouillage
possible d'une
seule main

Teleskopstange
stufenlos verstellbar
Telescopic bar
stepless adjustable
Barre de poignée
télescopique réglable
en hauteur



NEWSCHOOL SHOPPER®
PINK-SILBER/PINK-SILVER / ROSE-ARGENT
Art.-Nr.: 9-508-60



Praktische
Gurthalterung
Practical strap
holder
Fixation des sangles

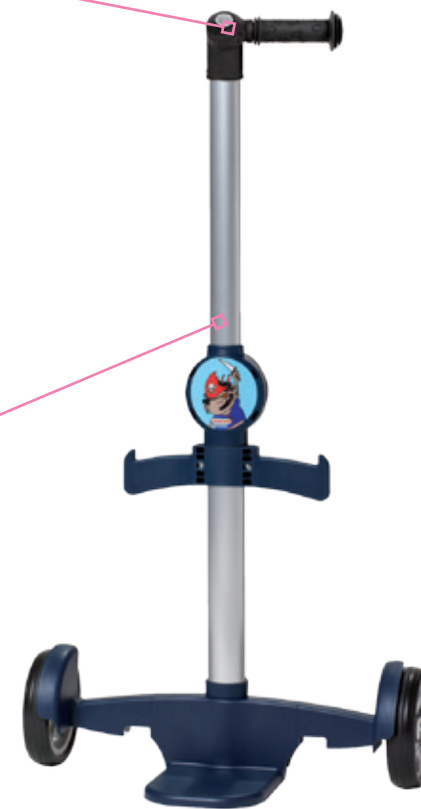

NEWSCHOOL SHOPPER®
BLAU-SILBER/BLUE-SILVER/BLEU-ARGENT
Art.-Nr.: 9-508-90

EIGENSCHAFTEN FAHRGESTELL · FEATURES FRAME/ CARACTÉRISTIQUES DU CHÂSSIS



BIKE & EASY

Kofferraum für's Fahrrad

Die Andersen Shopper®, die ans Fahrrad angehängt werden können, bieten clevere Transportlösungen beim Familienausflug, zum Einkaufen oder in der Freizeit. Quasi wie ein Kofferraum verfügt der Radler über zusätzlichen Stauraum, bei dem der Gepäckträger frei bleibt. Selbstverständlich kann der Shopper® auch ohne Fahrrad genutzt werden. Leichte Handhabung des Kupplungssystems, das bei Bedarf abgeschlossen werden kann, ermöglichen schnelles An- und Abkuppeln.

Da Taschen und Räder leicht abzunehmen sind und der Shopper® klein zusammenlegbar ist, kann er bei Nichtgebrauch leicht verstaut werden.

A trunk for the bike

The Anderson Shopper®, attachable to your bike, offers a clever transport solution during family or leisure excursions and shopping trips. Similar to the trunk of a car, the bicycle rider gets additional storage space while the storage rack of the bike itself remains free. Of course, the Shopper® can also be used without the bike. The simple and easy handling of the coupling system, lockable if needed, allows the quick coupling and decoupling of the Shopper®. If not in use, the bag and wheels can be easily detached, and the Shopper® folds up into a small package.

Un coffre pour le vélo

Les shoppers Andersen Shopper®, qui peuvent être accrochés au vélo, offrent des solutions de transport intelligentes lors d'excursions en familles, pour faire des courses ou pour les loisirs. La bicyclette dispose d'un espace de rangement pratiquement de la taille d'un coffre, avec lequel le porte-bagage reste libre. Il va sans dire que le shopper peut être également utilisé sans vélo. La facilité de maniement du système d'accouplement, qui peut être verrouillé au besoin, permet un accouplement et un désaccouplement faciles. Comme le sac et les roues sont faciles à enlever et que le Shopper® peut être plié en de petites dimensions, il est facile à ranger quand il n'est pas utilisé.



VIDEO



DIE VERSCHIEDENEN KUPPLUNGSANBINDUNGEN / THE VARIOUS COUPLING CONNECTIONS	
LES DIFFÉRENTES LIASONS D'ACCOUPEMENT	83
KUPPLUNGEN/ COUPLINGS/ ACCOUPLEMENTS	84-85
ZUBEHÖR/ EXTRAS/ ACCESSOIRES	86
DISPLAYS	87
FAHRRAD & FREIZEITANHÄNGER/BIKE TRAILER/ REMORQUES POUR VÉLO ET LES LOISIRS	88-89

DIE VERSCHIEDENEN KUPPLUNGSANBINDUNGEN/ THE VARIOUS COUPLING CONNECTIONS LES DIFFÉRENTES LIAISONS D'ACCOUPEMENT

Richtige Kupplung fürs Fahrrad und richtigen Kupplungsstift für den Shopper® finden!

Zur Befestigung werden zwei Komponenten benötigt:

1. Ein Kupplungsstift für den Shopper® (SH-1 oder SH-2, je nach Shopper® Modell)
2. Eine Kupplung für das Fahrrad (R1-BigEasy, G1-PullEasy, A1-EasySnap oder A2-RT Roll-it)

Die entsprechenden Voraussetzungen zur Befestigung der einzelnen Kupplungen finden Sie in der untenstehenden Grafik und/oder in der entsprechenden Artikelbeschreibung.

Alle vier Kupplungen sind mit dem gleichen Kupplungskopf ausgestattet. Somit lassen sich beide Kupplungsstifte (Befestigung am Shopper®) mit jeder Kupplung (Befestigung am Fahrrad) beliebig kombinieren.

Der Kupplungskopf verfügt über eine sogenannte Drehmomentstütze und kann so ein Umkippen des Shopper® verhindern.

Per Knopfdruck lässt sich der Shopper® einfach und schnell An- und Abkuppeln. Eine vorhandene Verriegelung bietet zusätzliche Sicherheit. Durch ein Schloss (teilweise Zubehör) lässt sich der Shopper® abschließen.

Bitte beachten Sie unbedingt die allgemeinen Sicherheitshinweise zur Benutzung eines Shopper® am Fahrrad und die entsprechende Montage- und Gebrauchsanleitung!

<http://www.andersen-shopper.de/service/bedienungsanleitungen>

Correct coupling for bikes and finding the correct coupling pin for the shopper!

Two components are required to attach the shopper®:

1. A coupling pin for the shopper® (SH-1 or SH-2, depending on the model of shopper)
2. A coupling for the bike (R1-BigEasy, G1-PullEasy, A1-EasySnap or A2-RT Roll-it)

You can find the corresponding requirements for attaching single couplings in the pictures below and/or in the corresponding item description.

All four couplings are fitted with the same coupling head. This means that both coupling pins (shopper® attachment) can be combined with any coupling (bike attachment) as required.

The coupling head has a so-called torque support and can therefore prevent the shopper® from tipping over.

The shopper® can be attached and removed with the touch of a button. The locking system provided offers additional safety. The shopper® can be locked with a key (partly accessories).

Please be aware of the general safety information for using a shopper with a bike and the corresponding instructions for assembly and use!

<http://www.andersen-shopper.de/en/service/directions-for-use>

Trouver le bon accouplement pour votre vélo et la bonne goupille d'accouplement pour votre shopper®!

Deux composants sont nécessaires à la fixation :

1. Une goupille d'accouplement pour le shopper® (SH-1 ou SH-2, selon le modèle de shopper®)
2. Un accouplement pour le vélo (R1-BigEasy, G1-PullEasy, A1-EasySnap ou A2-RT Roll-it)

Vous trouverez les conditions préalables pour la fixation des accouplements individuels dans le graphique ci-dessous et/ou dans la description d'article correspondante.

Les quatre accouplements sont équipés de la même tête d'accouplement. Ainsi, les deux goupilles d'accouplement (fixation au shopper®) peuvent être combinées à n'importe quel accouplement (fixation au vélo).

La tête d'accouplement dispose d'un support de couple qui permet d'éviter un basculement du shopper®.

Le shopper s'attache et se détache rapidement et facilement en appuyant sur un bouton. Le système de verrouillage offre une sécurité supplémentaire. Le shopper se verrouille à l'aide d'une serrure (en option).

Veuillez impérativement respecter les instructions générales de sécurité pour l'utilisation d'un shopper sur un vélo et le manuel d'utilisation de montage correspondant !

<http://www.andersen-shopper.de/fr/service/manuels-dutilisation>

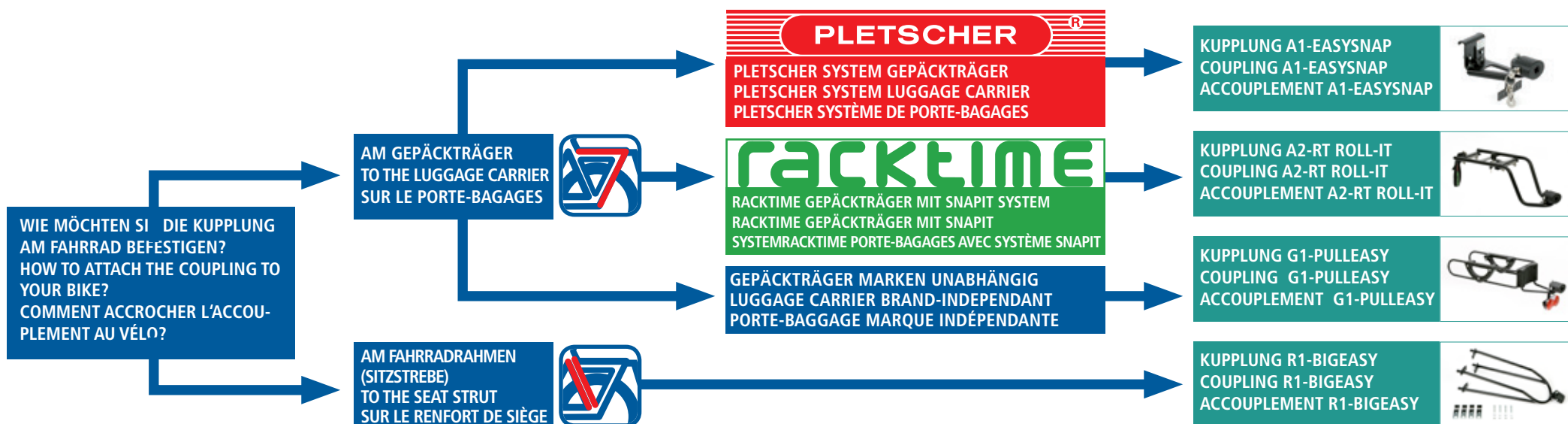

Was wird benötigt, um den Shopper® hinter das Fahrrad zu hängen? What is needed to hook up a Shopper® behind a bicycle? De quoi ai-je besoin pour fixer le Shopper® derrière le vélo?

1 FÜR DEN SHOPPER® FOR THE SHOPPER® POUR VOTRE SHOPPER®

SH-1

KUPPLUNGSSTIFT SH-1
COUPLING STUD SH-1
GOUPILLE D'ACCOUPLLEMENT SH-1



Art.-Nr.: 6-110-80

Kupplungsstift montiert am Shopper®
Coupling stud mounted on Shopper®
Goupille d'accouplement montée sur le Shopper®

PASSEND FÜR:
SUITABLE FOR THE FOLLOWING MODELS:
CONVENANT À:



SH-2

KUPPLUNGSSTIFT SH-2
COUPLING STUD SH-2
GOUPILLE D'ACCOUPLLEMENT SH-2



Art.-Nr.: 6-115-80

Kupplungsstift montiert am Shopper®
Coupling stud mounted on Shopper®
Goupille d'accouplement montée sur le Shopper®

PASSEND FÜR:
SUITABLE FOR THE FOLLOWING MODELS:
CONVENANT À:



2 FÜRS FAHRRAD

R1-BigEasy

KUPPLUNG R1-BigEasy
· Befestigung am Fahrradrahmen (Sitzstrebe). Gewicht: 1,2 kg
(Voraussetzung 10-22mm Durchmesser der Sitzstrebe)
· kein Gepäckträger notwendig

COUPLING R1-BigEasy
· Attaches to frame (seat stays). Weight: 1,2 kg
(Requires a 10-22mm diameter of the seat stay)
· No luggage carrier required

ACCOUPLLEMENT R1-BigEasy
· Fixation sur le cadre de vélo (haubans). Poids: 1,2 kg
Condition préalable 10-22 mm de diamètre de hauban
· Aucun porte-bagage nécessaire

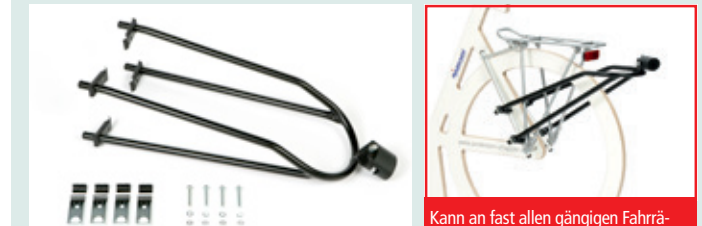

Art.-Nr.: 6-210-80
ohne Schloss/without lock/sans serrure
Art.-Nr.: 6-215-80
mit Schloss/with lock/avec serrure

Kann an fast allen gängigen Fahrrädern befestigt werden!
Can be attached to all customary bicycles.
Peut être fixé sur presque tous les vélos usuels



Unsere Kupplungsanbindungen sind so konzipiert, dass sie an möglichst viele unterschiedliche Fahrräder passen. Dennoch kann es bei der Vielzahl der auf dem Markt befindlichen Fahrräder passieren, dass Fahrrad, Kupplung und Shopper® nicht zueinander passen!

Our coupling connectors are designed such that they fit many different bicycles. However, given the multitude of different bikes on the market, a situation of non-matching bike, coupling and shopper® may occur.

Nos liaisons d'accouplement sont conçues de manière à convenir à des vélos aussi divers que possible. Il peut cependant arriver, vu la grande variété des vélos qui se trouvent sur le marché, que le vélo, l'accouplement et le shopper® ne conviennent pas ensemble !

FOR THE BIKE

POUR LE VÉLO

G1-PullEasy

KUPPLUNG G1-PullEasy – mit Schloss und Diodenrücklicht
 · Befestigung am Gepäckträger. Voraussetzung:
 stabiler Gepäckträger (mind. 25kg Tragkraft). Gewicht: 1,0 kg
 · Gepäckträgerbreite 103-170mm
 · Durchmesser Strebe 8-16mm

COUPLING G1-PullEasy – with lock and diode tail light
 · Attaches to the luggage carrier. Requires a solid luggage carrier
 with a minimum load capacity of 25 kg. Weight: 1,0 kg
 · Width of luggage carrier :103-170mm
 · Strut diameter 8-16mm

ACCOUPLLEMENT G1-PullEasy – avec serrure et feu arrière à diode
 · Fixation sur le porte-bagage. Condition préalable porte-bagage stable avec
 au moins 25 kg de capacité de charge. Poids: 1,0 kg
 · Largeur de porte-bagage de 103-170mm
 · Diamètre de renfort de 8-16 mm



A1-EasySnap®

KUPPLUNG A1-EasySnap® – mit Schloss
 · Passend für PLETSCHER Gepäckträger System:
 Vario, Genius, Genius Plus, Athlete System, Athlete Pumpe. Gewicht: 0,6 kg

COUPLING A1-EasySnap® – with lock
 · Fits PLETSCHER carrier system:
 Vario, Genius, Genius Plus, Athlete system, Athlete Pumpe. Weight: 0,6 kg

ACCOUPLLEMENT A1- EasySnap® – avec serrure
 · Seulement pour PLETSCHER système de porte-bagages:
 Vario, Genius, Genius Plus, Athlete system, Athlete Pumpe. Poids: 0,6 kg

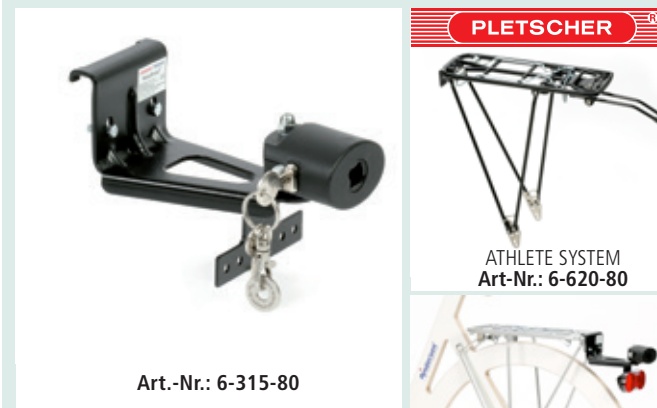

A2-RT Roll-it

KUPPLUNG A2-RT Roll-it – mit Schloss (Kupplung ohne SNAP/IT Funktion)
 · Passend für RACKTIME Gepäckträger mit SNAP/IT-System (abschließbar).
 Plattform Innenmaß: 120 mm
 · Gewicht: 1,3 kg

COUPLING A2-RT Roll-it – with lock (Coupling without use of SNAP/IT)
 · fits RACKTIME carrier with SNAP/IT-system (lockable)
 · Inside dimension platform: 120 mm
 · Weight: 1,3 kg

ACCOUPLLEMENT A2-RT Roll-it – avec serrure (Accouplement sans fonction de SNAP/IT)
 · Seulement pour RACKTIME porte-bagage avec SNAP/IT-System (fermant à clé)
 Dimension de plateforme: 120 mm
 · Poids: 1,3 kg



PLETSCHER ZUBEHÖR / PLETSCHER EXTRAS / PLETSCHER ACCESSOIRES



Silber/silver/argent
Art.-Nr.: 6-620-20



SCHWARZ/BLACK/NOIR
Art.-Nr.: 6-620-80

ATHLETE SYSTEM-GEPÄCKTRÄGER, verstellbar, Befestigung auf Rahmenösen.
ATHLETE SYSTEM CARRIER, adjustable, attachment with eyelets
SYSTÈME PORTE-BAGAGES ATHLETE réglable fixation, par anneaux

Art.-Nr.: 6-624-80



EINKAUFSKORB inkl. Adapter.
SHOPPING BASKET incl. adapter.
CORBEILLE avec l'adaptateur.

SHOPPER® ZUBEHÖR
SHOPPER® EXTRAS
SHOPPER® ACCESSOIRES



Art.-Nr.: 9-890-30

REGENCAPE : Passend für alle Shopper®
RAIN CAPE: Fits on all Shopper®
PONCHO IMPERMÉABLE: Approprié à tous les Shopper®

RACKTIME ZUBEHÖR / RACKTIME EXTRAS / RACKTIME ACCESSOIRES



Fold-it adjustable

Silber/silver/argent
Art.-Nr.: 6-622-20
inkl. Clamp-it / incl. Clamp-it / inclu Clamp-it



Fold-it adjustable

schwarz/black/noir
Art.-Nr.: 6-622-80
inkl. Clamp-it / incl. Clamp-it / inclu Clamp-it

Gepäckträger RACKTIME Fold-it adjustable (verstellbare Fußbleche für 26' - und 28' - Rahmen)
RACKTIME carriers Fold-it adjustable (adjustable feet plates for 26' - and 28' - frames)
porte-bagages RACKTIME Fold-it adjustable (piètement réglable pour 26' - et 28' - cadres)



Art.-Nr.: 6-873-80



Art.-Nr.: 6-873-80

DIODENRÜCKLICHT (mit Batterien) passend für den Kupplungsstift SH-1
(Art.Nr.: 6-110-80) und Royal Shopper® Plus und Tura Shopper®.
TAILLIGHT (with batteries) adaptable for coupling stud SH-1
(Art.Nr.: 6-110-80), Royal Shopper® Plus and Tura Shopper®.
Diode de feu arrière (avec piles) adaptable pour goupille d'accouplement SH-1 (Art.Nr.: 6-110-80), pour le Royal Shopper® Plus et Tura Shopper®.



BIKE & EASY DISPLAY PLETSCHER



Art.-Nr.:551
ohne Kupplung/without coupling/sans accouplement

PLETSCHER®



Passend für Kupplung / Suitable for coupling / Convenant à l'accouplement:
R1-BigEasy, G1-PullEasy, A1-EasySnap®

BIKE & EASY DISPLAY RACKTIME

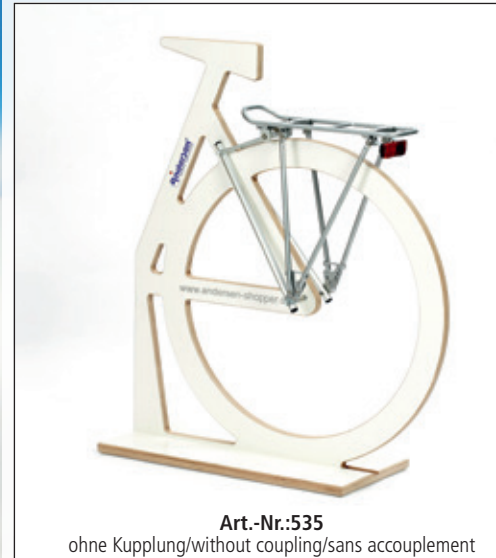

Art.-Nr.:535
ohne Kupplung/without coupling/sans accouplement

racktime



Passend für Kupplung / Suitable for coupling / Convenant à l'accouplement:
R1-BigEasy, G1-PullEasy, A2-RT Roll-it

DISPLAY FÜR SHOPPER® / DISPLAYS FOR SHOPPER® / PRESENTOIR POUR SHOPPER®

Platz für mindestens 7 Shopper®
For minimum 7 Shopper®
pour minimum Shopper®

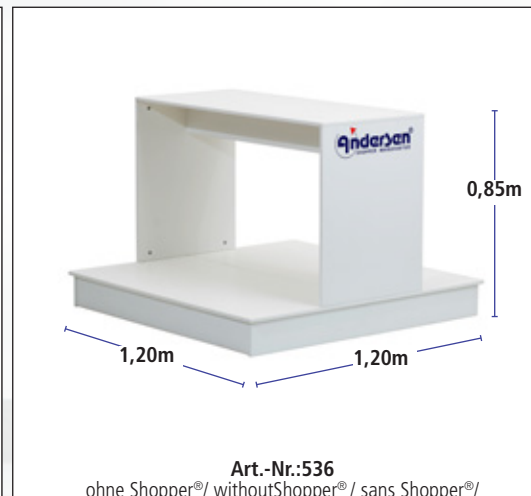

Art.-Nr.:536
ohne Shopper®/ without Shopper®/ sans Shopper®/

DER KOFFERRAUM FÜR IHR FAHRRAD THE TRUNK FOR YOUR BICYCLE LE COFFRE À BAGAGE POUR VOTRE VÉLO

Der Fahrrad & Freizeitanhänger besteht aus einer stabilen Stahlrohrkonstruktion (ø 16mm). Seine faltbare extra-große 60l Kunststoffbox kann sehr leicht aus dem Gestell herausgenommen werden. Ohne Umbau ist der Fahrrad & Freizeitanhänger auch als Handwagen einsetzbar.

The bike-trailer is made of solid steel tubes (ø16mm). The foldable extra-large 60l plastic box can easily be detached from the frame. The bike-trailer & free time trailer can also be used as handcart without conversion.

La remorque pour vélo et les loisirs est composée d'une construction solide en tubes d'acier. Sa caisse en plastique pliable extra grande de 60 litres s'enlève très facilement du châssis. Sans oublier que la remorque pour vélo et les loisirs peut aussi servir de caddie sans transformations.

FAHRRAD & FREIZEITANHÄNGER FUN

FAHRRAD&FREIZEITANHÄNGER FUN
mit Faltbox und kuggelgelagertem Leichtlauftrad.
BIKE-TRAILER FUN
with folding box and ball-bearing easy-running-wheels.
REMORQUE POUR VÉLO FUN
avec caisse pliante et roues à roulement à billes



EIGENSCHAFTEN / FEATURES/CARACTÉRISTIQUES



FAHRRAD&FREIZEITANHÄNGER FUN
mit Faltbox, Abdeckplane und kuggelgelagerter Luftbereifung.
BIKE-TRAILER FUN
with folding box, canvas cover and ball-bearing pneumatic tires
REMORQUE POUR VÉLO FUN
avec caisse pliante, bâche et pneumatiques à roulement à billes



EIGENSCHAFTEN / FEATURES/CARACTÉRISTIQUES



KUPPLUNG / COUPLING / ACCOUPLEMENT FUN

Die Kupplung FUN wird ganz einfach mit zwei Schrauben an der Sattelstütze montiert. Durch die mitgelieferten Adapter (ø26mm, ø27mm, ø29mm) lässt sich die Kupplung an nahezu alle gängigen Sattelstützen von 26mm-32mm befestigen.

The FUN coupling is assembled quite simply with two screws to the saddle support. The coupling can be attached to almost all current saddle supports from 26mm-32mm with the adapter provided (ø26mm, ø27mm, ø29mm).

L'accouplement FUN se monte très facilement à la tige d'appui de la selle à l'aide de deux vis. Grâce aux adaptateurs fournis (ø26mm, ø27mm, ø29mm), l'accouplement se fixe à presque toutes les tiges de selle courantes de 26 mm à 32 mm.



Art.-Nr. 6-606-80



Art.-Nr. 6-607-80

Bei „Easy“ bleibt der Gepäckträger frei!
 With „Easy“ the carrier is left vacant for usage!
 Le porte-bagages reste libre!

FAHRRAD & FREIZEITANHÄNGER EASY

FAHRRAD&FREIZEITANHÄNGER EASY
 mit Faltbox und kugelgelagertem Leichtlauftrad.
 BIKE-TRAILER EASY
 with folding box and ball-bearing easy-running-wheels.
 REMORQUE POUR VÉLO EASY
 avec caisse pliante et roues à roulement à billes



EIGENSCHAFTEN / FEATURES/CARACTÉRISTIQUES



FAHRRAD&FREIZEITANHÄNGER EASY
 mit Faltbox, Abdeckplane und kugelgelagerter Luftbereifung.
 BIKE-TRAILER EASY
 with folding box, canvas cover and ball-bearing pneumatic tires.
 REMORQUE POUR VÉLO EASY
 avec caisse pliante, bâche et pneumatiques à roulement à billes



EIGENSCHAFTEN / FEATURES/CARACTÉRISTIQUES



RÜCKLICHT / TAILLIGHT / FEU ARRIÈRE



Diodenrücklicht passend für alle Fahrrad & Freizeitanhänger
 Taillight fits all Bike-Trailers
 Diode de feu arrière pour la fixation sur remorques pour vélo et les loisirs

KUPPLUNGEN / COUPLINGS / ACCOUPLEMENTS

KUPPLUNG R1-BigEasy
 COUPLING R1-BigEasy
 ACCOUPLEMENT R1- BigEasy



KUPPLUNG G1-PullEasy
 - mit Schloß und Diodenrücklicht
 COUPLING G1-PullEasy
 - with lock and diode tail light
 ACCOUPLEMENT G1-PullEasy
 - avec serrure et feu arrière à diode



KUPPLUNG A1-EasySnap®
 - mit Schloss
 COUPLING A1-EasySnap®
 - with lock
 ACCOUPLEMENT A1- EasySnap®
 - avec serrure



KUPPLUNG A2-RT Roll-it
 - mit Schloss
 COUPLING A2-RT Roll-it
 - with lock
 ACCOUPLEMENT A2-RT Roll-it
 - avec serrure



TRANSPORT

KOFFEROLLER / TROLLEY / DIABLES À BAGAGES



Kofferoller

Seitlich unbegrenzt
No limit sideways
Tout gabarit de charge possible

20KG
Art.-Nr.: 1-545-80

EIGENSCHAFTEN · FEATURES · CARACTÉRISTIQUES



Mit KistenFix
With KistenFix
Avec KistenFix



Seitlich unbegrenzt
No limit sideways
Tout gabarit de charge possible

30KG
Art.-Nr.: 1-555-80

EIGENSCHAFTEN · FEATURES · CARACTÉRISTIQUES



ZUBEHÖR/ EXTRAS/ ACCESSOIRES

Sicherheits-Expander (ca. 80cm)
Safety strap (ca. 80cm)
Sandow de sécurité (ca. 80cm)



Art.-Nr.: 16

Sicherheits-Expander (ca. 180cm)
Safety strap (ca. 180cm)
Sandow de sécurité (ca. 180cm)



Art.-Nr.: 18

SHOPPER® GESTELL/ FRAME/ CHÂSSIS

Scala PLUS
SHOPPER®
ALUMINIUM

Art.-Nr.: 133-000-80



Seitlich unbegrenzt
No limit sideways
Tout gabarit de charge possible



Mit KistenFix
With KistenFix
Incl. KistenFix



EIGENSCHAFTEN FAHRGESTELL · FEATURES FRAME/ CARACTÉRISTIQUES DU CHÂSSIS



Art.-Nr.: 115-000-80



Seitlich unbegrenzt
No limit sideways
Tout gabarit de charge possible



EIGENSCHAFTEN FAHRGESTELL · FEATURES FRAME / CARACTÉRISTIQUES DU CHÂSSIS



Art.-Nr.: 166-000-80

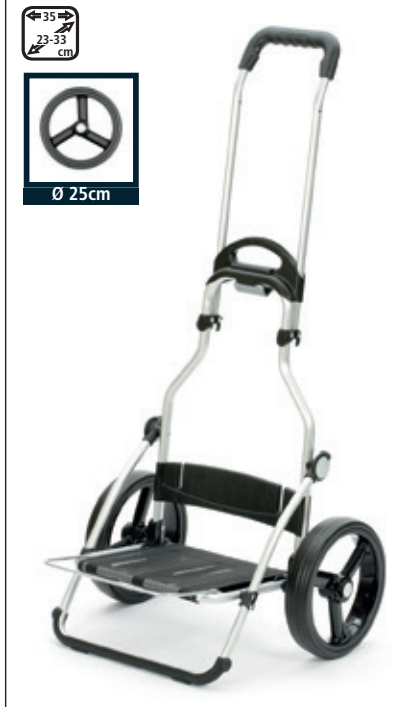

EIGENSCHAFTEN FAHRGESTELL · FEATURES FRAME / CARACTÉRISTIQUES DU CHÂSSIS



Art.-Nr.: 150-000-80



EIGENSCHAFTEN FAHRGESTELL · FEATURES FRAME / CARACTÉRISTIQUES DU CHÂSSIS



Die robusten Zeitungsroller mit Höhenverstellung. Der samtweiche Griff ist ein hervorragender Wärme- und Kälteschutz. Da macht das Austragen der Zeitungen gleich doppelt Spaß.

Sturdy newspaper trolleys with adjustable height. The grip is as soft as velvet and provides excellent protection against heat and cold. You'll have twice as much fun delivering newspapers.

Chariots pour sacs de journaux robustes et réglables en hauteur. La poignée douce comme du velours est une excellente protection contre la chaleur et le froid. La distribution des journaux fait doublement plaisir avec de l'aide.

**Zeitungs
Roller**



ALPHA



Zeitungsroller komplett mit 2 Taschen · Newspaper trolley with 2 bags
Chariot à journaux avec 2 sacoches
(Art.Nr.: 1-111-20 + 2x Art.Nr.: 9-101-90)
Art.-Nr.: 1-120-90

Zum Zeitungsroller die passende Tasche: aus wetterbeständigem Material, mit extra großem Überschlag, verstärkten Nähten und Taschenrücken, Reflektoren und transparentem Einschub auf dem Deckel für Werbung.

The bag for the newspaper trolley: made of weatherproof material, with extra big cover on top, strong seams and backside, reflector and a transparent pouch for commercial things.

Sacoches pour chariot à journaux :
Fabriquée avec un matériau imperméable aux coutures ultra résistantes, équipée d'un grand rabat, d'un dos renforcé, de bandes réfléchissantes et d'une poche transparente.



Zeitungsrollertasche / The bag for the newspaper trolley
Sacoches pour chariot à journaux
Art.Nr.: 9-101-90

EIGENSCHAFTEN TASCHEN
FEATURES BAG / CARACTÉRISTIQUES DU SAC



Zeitungsroller (ohne Taschen) · Größe: (BxHxT) 50x106-119x51cm
Newspaper trolley (without bags) · Size: (WxHxD) 50x106-119x51cm
Chariot à journaux (sans sacoches) · Taille: (LxHxP) 50x106-119x51cm
Art.-Nr.: 1-111-20

EIGENSCHAFTEN FAHRGESTELL · FEATURES FRAME / CARACTÉRISTIQUES DU CHÂSSIS



SHOPPER® SERIEN
SHOPPER® SERIES
SÉRIES SHOPPER®

GESTELL
FRAME
CHÂSSIS

EIGENSCHAFTEN FAHRGESTELL
FEATURES FRAME
CARACTÉRISTIQUES DU CHÂSSIS









		<p>121-000-*</p>		
		<p>140-000-*</p>		
<p>Kugellagerad ball-bearing wheel roue à roulement à billes Ø 29cm</p>		<p>135-000-*</p>		
<p>luftbereiftes Kugellagerad pneumatic ball-bearing wheel roue pneumatique à roulement à billes Ø 29cm</p>		<p>136-000-*</p>		
		<p>112-000-*</p>		
		<p>119-000-80</p>		
		<p>133-000-80</p>		
		<p>115-000-80</p>		
		<p>185-000-80</p>		
		<p>198-000-80</p>		

SHOPPER® SERIEN
SHOPPER® SERIES
SÉRIES SHOPPER®

GESTELL
FRAME
CHÂSSIS

EIGENSCHAFTEN FAHRGESTELL
FEATURES FRAME
CARACTÉRISTIQUES DU CHÂSSIS

				
<p>3-Speichenrad 3-spoke wheel roue à 3 rayons Ø 25cm</p>		<p>166-000-80</p> 	<p>SEITE/PAGE/PAGE: 36-41</p>	
<p>Metallspeichenrad spoked metal wheel roue à rayons métalliques Ø 25cm</p>		<p>168-000-80</p> 	<p>SEITE/PAGE/PAGE: 42-43</p>	
<p>Kugellagerad ball-bearing wheel roue à roulement à billes Ø 25cm</p>		<p>167-000-80</p> 	<p>SEITE/PAGE/PAGE: 45-47</p>	
<p>luftbereiftes Kugellagerad pneumatic ball-bearing wheel roue pneumatique à roulement à billes Ø 25cm</p>		<p>163-000-80</p> 	<p>SEITE/PAGE/PAGE: 48-49</p>	
<p>Kugellagerad ball-bearing wheel roue à roulement à billes Ø 29cm</p>		<p>164-000-80</p> 	<p>SEITE/PAGE/PAGE: 50-51</p>	
<p>luftbereiftes Kugellagerad pneumatic ball-bearing wheel roue pneumatique à roulement à billes Ø 29cm</p>		<p>165-000-80</p> 	<p>SEITE/PAGE/PAGE: 52-53</p>	
		<p>169-000-80</p> 	<p>SEITE/PAGE/PAGE: 64-67</p>	

				
<p>Kugellagerad ball-bearing wheel roue à roulement à billes Ø 25cm</p>		<p>147-000-80</p> 	<p>SEITE/PAGE/PAGE: 54-55</p>	
<p>luftbereiftes Kugellagerad pneumatic ball-bearing wheel roue pneumatique à roulement à billes Ø 25cm</p>		<p>143-000-80</p> 	<p>SEITE/PAGE/PAGE: 56-57</p>	

TASCHE BAG / SAC	FARBEN TASCHEN COLOURS BAGS / COULEURS DE SACS	GESTELL FRAME / CHÂSSIS	EIGENSCHAFTEN TASCHE FEATURES BAG / CARACTÉRISTIQUES DU SAC
MEER 2-132-* 80/90		UNUS SHOPPER® FUN / ALU STAR SHOPPER® / ROYAL SHOPPER®	
IKO 2-133-* 50/70/80/90		UNUS SHOPPER® FUN / SCALA SHOPPER® / TREPPENSTEIGER ROYAL SHOPPER®	
EDA 2-134-* 80/90		ALU STAR SHOPPER® / ROYAL SHOPPER® / TREPPENSTEIGER SCALA SHOPPER®	
TILLY 2-135-* 50/70/80/90		UNUS SHOPPER® / SCALA SHOPPER® PLUS / ROYAL SHOPPER® / KOMFORT SHOPPER®	
KIRA 2-136-* 50/70/80/90		UNUS SHOPPER® / SCALA SHOPPER® / QUATTRO SHOPPER® / ROYAL SHOPPER® TREPPENSTEIGER SCALA SHOPPER® / TREPPENSTEIGER ROYAL SHOPPER®	
LILO 2-137-* 70/80		UNUS SHOPPER® / SCALA SHOPPER® PLUS / ROYAL SHOPPER® TREPPENSTEIGER SCALA SHOPPER®	
ALBA 2-138-* 70/80		SCALA SHOPPER® / QUATTRO SHOPPER® / ROYAL SHOPPER® TREPPENSTEIGER ROYAL SHOPPER®	
BEA 2-139-* 20/70		UNUS SHOPPER® FUN / SCALA SHOPPER® / SCALA SHOPPER® PLUS	
LIZZY 2-140-* 70/90		UNUS SHOPPER® FUN / UNUS SHOPPER® ROYAL SHOPPER® / TREPPENSTEIGER SCALA SHOPPER®	
SILA 2-141-* 20/80		UNUS SHOPPER® / SCALA SHOPPER® PLUS / QUATTRO SHOPPER® / ROYAL SHOPPER® TREPPENSTEIGER ROYAL SHOPPER®	
CLINT 2-142-* 50/70		TURA SHOPPER® / ROYAL SHOPPER® PLUS	
FADO 2-138-* 50/70		TURA SHOPPER® / ROYAL SHOPPER® PLUS	

* ART.-NR. bitte um den Farbcode ergänzen / Please add colour code to article number / Code couleur en complément

RAD WHEEL ROUE	ART-NR:	GRÖSSE SIZE TAILLE	PASSEND FÜR SHOPPER® FITS ON SHOPPER® ADAPTABLE AU SHOPPER®	RAD WHEEL ROUE	ART-NR:	GRÖSSE SIZE TAILLE	PASSEND FÜR SHOPPER® FITS ON SHOPPER® ADAPTABLE AU SHOPPER®	RAD WHEEL ROUE	ART-NR:	GRÖSSE SIZE TAILLE	PASSEND FÜR SHOPPER® FITS ON SHOPPER® ADAPTABLE AU SHOPPER®
	3-306-80		SCALA SHOPPER® QUATTRO SHOPPER® (VORN)		3-306-90		SCALA SHOPPER®		3-311-20		SCALA SHOPPER® PLUS
	3-316-20		UNUS SHOPPER® FUN		3-322-20		ALU STAR SHOPPER®		3-321-80		QUATTRO SHOPPER® (HINTEN) KOMFORT SHOPPER®
	3-326-80		ROYAL SHOPPER® ROYAL SHOPPER® PLUS		3-332-80		ROYAL SHOPPER® ROYAL SHOPPER® PLUS KORB SHOPPER® XXL		3-341-20		ROYAL SHOPPER® ROYAL SHOPPER® PLUS FAHRRAD&FREIZEITANHÄNGER
	3-351-20		ROYAL SHOPPER® ROYAL SHOPPER® PLUS FAHRRAD&FREIZEITANHÄNGER		3-346-80		TREPPENSTEIGER SCALA SHOPPER® TREPPENSTEIGER ROYAL SHOPPER®		3-366-80		TURA SHOPPER® ROYAL SHOPPER®
	3-367-20		TURA SHOPPER® ROYAL SHOPPER®		3-307-20		NEW SCHOOL SHOPPER®		3-331-80		KORB SHOPPER®

EINBLICKE IN DIE FIRMENGESCHICHTE / INSIGHTS INTO THE COMPANY HISTORY

UN APERÇU DE L'HISTOIRE DE L'ENTREPRISE



Gründer-Ehepaar Andersen auf der Internationalen Hausrat- und Eisenwarenmesse in Köln 1966.

Founding couple Andersen at the International Household Goods and Hardware Fair (Hausrat- und Eisenwarenmesse) in Cologne 1966.

Le couple Andersen, fondateur de l'entreprise, au salon de l'ameublement et de la quincaillerie (Hausrat- und Eisenwarenmesse) de Cologne en 1966.



Ein Werbeflyer von 1959. Bügeltische und Leitern gehörten zum Sortiment.

An advertising leaflet from 1959. Ironing boards and ladders were part of the range.

Un flyer publicitaire de 1959. Des tables à repasser et des escabeaux font partie de la gamme de produits.



Die ersten eigenen Shopper® werden zunächst im elterlichen Pferdestall in Havetoftlojt produziert.

The first Shopper® were produced in the parental horse stable in Havetoftlojt.

Les premiers Shopper® sont d'abord produits dans l'étable familiale à Havetoftlojt, un village du nord de l'Allemagne.



1959 – Das Biegen der Rohre erfolgt per Muskelkraft an selbst-konstruierten Werkzeugen.

1959 – The pipes are bent with muscle strength using self-designed tools.

1959 – Le pliage des tubes est effectué à la force du poignet avec des outils fabriqués à la main.



Das erste Logo 'GÜNA' setzte sich aus GÜNter Andersens Vor- und Nachnamen zusammen.

The first 'GÜNA' logo was made up of GÜNter Andersen's first and last name.

Le premier logo « GÜNA » se compose des nom et prénom de GÜNter Andersen.



Der erste Katalog 1959 mit GÜNA Marktrollern aus der eigenen Produktion.

The first catalogue in 1959 with GÜNA market trolleys from their own production.

Le premier catalogue de 1959 avec des poussettes de marché GÜNA de leur propre production.



Nachts, wenn die Kinder schlafen, pinselt das junge Ehepaar die Gestelle von Hand.

At night when the children are asleep, the young couple paint the frames by hand.

La nuit, pendant que les enfants dorment, le jeune couple peint les cadres à la main.



Produktkarte 70er Jahre Product chart from the 70's Carte des produits dans les années 70



Der Versand 1969 Dispatch 1969 L'expédition en 1969



Flucht im Einkaufswagen 1987 (Zeitschrift Quick)
Escape in the shopping trolley 1987 (Quick Magazine)
Fuite dans un chariot en 1987 (magazine Quick)



Sven Andersen mit Tochter Scorlan 2007 mit „Fluchtschopper“ im berühmten Museum Checkpoint Charlie.
Sven Andersen with daughter Scorlan in 2007 with the shopping trolley, that has been used for the escape in the famous Checkpoint Charlie museum

Sven Andersen et sa fille Scorlan en 2007 avec le chariot (pris pour le fuite) dans le célèbre musée Checkpoint Charlie



Shopper® Modell 60' Jahre
Shopper® modell from the 60'
Modele de Shopper® des années 60'

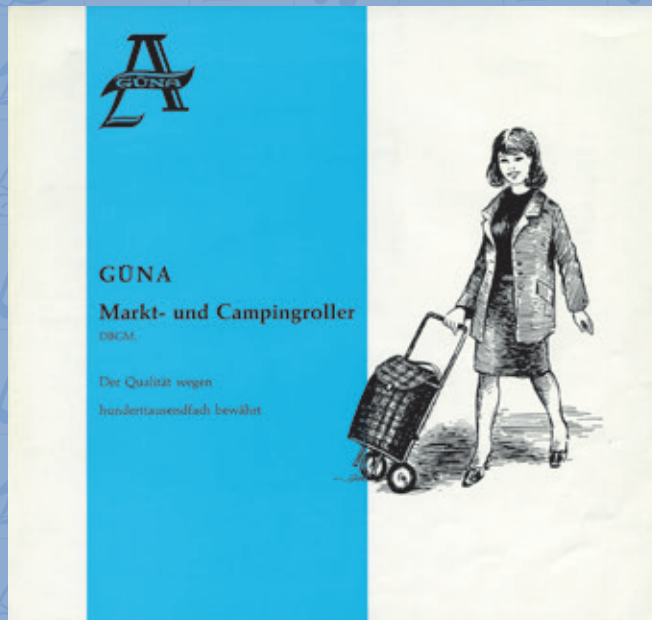

Katalog/ Catalogue/ Catalogue 1965



Katalog/ Catalogue/ Catalogue 1976



Katalog/ Catalogue/ Catalogue 1986



Katalog/ Catalogue/ Catalogue 1996



Katalog/ Catalogue/ Catalogue 2006



Katalog/ Catalogue/ Catalogue 2008



Katalog/ Catalogue/ Catalogue 2014

1958 DER HACKENPORSCHER WIRD GEBOREN!

In Satrup geboren und nach 60 Jahren immer noch „Made in Germany“ mit rund 10 Millionen verkauften Shopper®: der Hackenporscher.
1958, in der wirtschaftlichen Aufschwungphase, beschließt das Ehepaar Andersen rollende Einkaufstaschen herzustellen.

Zu Anfang wird alles eigenhändig im väterlichen Pferdestall bei Satrup gemacht: gesägt, gebogen, genietet und nachts lackiert. Die Nachfrage steigt und schnell ist klar: das ist im Pferdestall und vor allem nur zu zweit nicht mehr machbar. Es werden Mitarbeiter eingestellt und bereits 1962 zieht man in die erste eigene Produktionsstätte um.

Vom geraden Rohr bis zum fertigen Shopper®: noch heute werden die Produkte im Hause Andersen entwickelt, designt und hergestellt, so dass die Produktvielfalt heute riesig ist und die verschiedensten Typen umfasst: Gestelle aus Aluminium, mit Sitz, mit Kugellagerrädern; Taschen mit Kühlfach bis hin zu Shopper®n mit Taschen aus gebrauchter LKW-Plane und Segeltuch.

Die neue Generation Shopper® läutet der Unus Shopper® ein. Mit cooler Aluminium Optik, kugelgelagerten Niederquerschnittsreifen, belastbarem Gestell und federleichten Einstellmechanismen sowohl für die Höhenverstellung als auch für den 3-Wege-System Griff.

Die Firma Andersen Shopper Manufaktur ist Marktführer in Deutschland und mit 35% Exportanteil auch in vielen anderen europäischen Ländern.

Im November 2008 wurde die Firma, inzwischen in 2. Generation geführt, 50 Jahre jung, was nicht verwunderlich ist, denn in der im hohen Norden Deutschlands gelegenen Firma wird seit jeher höchster Wert auf Qualität und Innovation gelegt.

Im Jahr 2014 startet die Andersen Shopper Manufaktur die Kooperation mit dem renommierten Sportartikelhersteller Ortlieb, um einen Shopper® mit wasserfester Tasche herzustellen.

Auch ein ungewöhnliches Material kommt für Taschen zum Einsatz: gebrauchtes, extrem belastbares und wasserabweisendes Segeltuch startet nach diversen Törns über die Weltmeere jetzt sein zweites Leben als funktionale Tasche.

1958 THE FUTURE ANDERSEN COMPANY IS BORN!

Since 1958, Mr and Mrs Andersen decided to manufacture shopping bags on wheels. They started in a horse stable near Satrup in the north of Germany: they sawed, bent tubes, nailed, assembled trolleys and finished with a coat of varnish at night.

Demand exploded and they realised that it was becoming impossible to continue on their own, in a stable. They expanded and moved to their first factory premises in 1962.

All shopping trolleys are still designed, developed and thoroughly manufactured in the Andersen factory, starting from the framework to the finished Shopper®. This involves a huge variety of Shopper® and equipment : aluminium tubing, seats, ball bearing wheels, telescopic handles, cooler bags, tarpaulin bags, sailcloth,...

The new generation Shopper® is launched with the Unus Shopper®: its cool futuristic look with oval aluminium tubing, its low-profile ball bearing wheels and its easy height adjustment and 3-way-system grip.

Andersen Shopper Manufaktur is the leader on the German market of shopping trolleys and is doing extremely well in many European countries with an export share of 35%.

In November 2008 the family-owned company celebrated its 50th anniversary with 10 million "Made in Germany" Shopper® sold. This comes as no surprise as Andersen Shopper Manufaktur has always valued quality and innovation.

In 2014 the Andersen Shopper Manufaktur co-operates with Ortlieb, a renowned producer of waterproof bags, to create a Shopper® with a waterproof bag.

In addition, an unusual material is used for bags: used, extremely resilient and water-repellent sail cloth is now starting its second life as a functional bag after various trips across the seas.

1958 NAISSANCE DE LA FUTURE ENTREPRISE ANDERSEN

En 1958, Monsieur et Madame Andersen décidèrent de fabriquer des sacs à provisions sur roulettes. Pour ce faire, ils s'installèrent dans une étable près de la ville de Satrup dans le nord de l'Allemagne : ils sciaient, pliaient des tubes, clouaient, assemblaient les poussettes de marché et pendant la nuit passaient une couche finale de vernis noir.

Dépassés par la demande, ils réalisèrent vite qu'il devenait impossible de continuer seuls dans une étable. En 1962, ils s'agrandirent et allèrent s'installer non loin de là, sur le site de leur première usine.

Toutes les poussettes de marché sont encore maintenant conçues, élaborées et fabriquées du début à la fin dans l'usine Andersen. Et cela donne un éventail infini de modèles aux styles et caractéristiques différents : tubes en aluminium, roues à roulement à billes, poignées télescopiques, sièges, sacs isothermes, sacs en toile de bâche recyclés, toile à voile...

La nouvelle génération de Shopper® est lancée avec l'Unus Shopper®. Sa tubulure ovale en aluminium et ses roues basses à roulement à billes lui donnent un look futuriste. Réglable en hauteur, il est également facile à manier grâce à sa poignée 3 positions.

Andersen Shopper Manufaktur est le leader du marché allemand des poussettes de marché et, avec 35% d'exportation, se trouve en excellente position dans beaucoup de pays européens.

En novembre 2008, l'entreprise familiale a célébré son 50ème anniversaire avec 10 millions de poussettes de marché « Made in Germany » vendues. Cette longévité et ce succès sont dus sans aucun doute à son souci constant de qualité et d'innovation.

En 2014, Andersen et la société Ortlieb, fabricant allemand réputé de sacs imperméables, s'associent pour lancer un Shopper® fabriqué par Andersen équipé d'un sac imperméable fabriqué par Ortlieb.

Un matériau inhabituel est également utilisé pour les sacs : une toile à voile usagée extrêmement résistante et hydrofuge commence maintenant sa seconde vie en tant que sac fonctionnel après diverses sorties sur les mers du globe.



1960

1970

1980

1990

SHOPPER® SERIEN
SHOPPER® SERIES
SÉRIES SHOPPER®

GESTELL
FRAME
CHÂSSIS

EIGENSCHAFTEN FAHRGESTELL
FEATURES FRAME
CARACTÉRISTIQUES DU CHÂSSIS

		121-000- *		SEITE/PAGE/PAGE: 4-7
		140-000- *		SEITE/PAGE/PAGE: 8-13
Kugellagerad ball-bearing wheel roue à roulement à billes Ø 29cm		135-000- *		SEITE/PAGE/PAGE: 14-17
luftbereiftes Kugellagerad pneumatic ball-bearing wheel roue pneumatique à roulement à billes Ø 29cm		136-000- *		SEITE/PAGE/PAGE: 18-19
		112-000- *		SEITE/PAGE/PAGE: 20-23
		119-000-80		SEITE/PAGE/PAGE: 60-63
		133-000-80		SEITE/PAGE/PAGE: 24-27
		115-000-80		SEITE/PAGE/PAGE: 28-31
		185-000-80		SEITE/PAGE/PAGE: 32-35
		198-000-80		SEITE/PAGE/PAGE: 58-59

* ART.-NR. bitte um den Farbcode ergänzen / Please add colour code to article number / Code couleur en complément

SHOPPER® SERIEN
SHOPPER® SERIES
SÉRIES SHOPPER®

GESTELL
FRAME
CHÂSSIS

EIGENSCHAFTEN FAHRGESTELL
FEATURES FRAME
CARACTÉRISTIQUES DU CHÂSSIS

ROYAL
SHOPPER®
ALUMINIUM



3-Speichenrad
3-spoke wheel
roue à 3 rayons
Ø 25cm



SEITE/PAGE/PAGE: 36-41



Metallspeichenrad
spoked metal wheel
roue à rayons
métalliques
Ø 25cm



SEITE/PAGE/PAGE: 42-43



Kugellagerad
ball-bearing wheel
roue à roulement
à billes
Ø 25cm



SEITE/PAGE/PAGE: 45-47



luftbereiftes
Kugellagerad
pneumatic
ball-bearing wheel
roue pneumatique à
roulement à billes
Ø 25cm



SEITE/PAGE/PAGE: 48-49



Kugellagerad
ball-bearing wheel
roue à roulement
à billes
Ø 29cm



SEITE/PAGE/PAGE: 50-51



luftbereiftes
Kugellagerad
pneumatic
ball-bearing wheel
roue pneumatique à
roulement à billes
Ø 29cm



SEITE/PAGE/PAGE: 52-53



ROYAL
SHOPPER®
ALUMINIUM
TREPPENSTEIGER

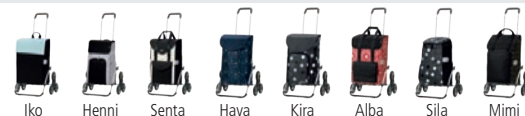

SEITE/PAGE/PAGE: 64-67



ROYAL PLUS
SHOPPER®
ALUMINIUM

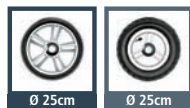

Kugellagerad
ball-bearing wheel
roue à roulement
à billes
Ø 25cm



SEITE/PAGE/PAGE: 54-55



luftbereiftes
Kugellagerad
pneumatic
ball-bearing wheel
roue pneumatique à
roulement à billes
Ø 25cm



SEITE/PAGE/PAGE: 56-57



TASCHE BAG / SAC	FARBEN TASCHEN COLOURS BAGS / COULEURS DE SACS	GESTELL FRAME / CHÂSSIS	EIGENSCHAFTEN TASCHES FEATURES BAG / CARACTÉRISTIQUES DU SAC
HERA 2-004- [*] 22/72/82/92		SCALA SHOPPER® / ROYAL SHOPPER® / TREPPENSTEIGER SCALA SHOPPER®	
SENTA 2-028- [*] 00/80		QUATTRO SHOPPER® / ROYAL SHOPPER® / TREPPENSTEIGER ROYAL SHOPPER®	
HYDRO 2-036- [*] 50/70/80/90		TURA SHOPPER® / ALU STAR SHOPPER® / ROYAL SHOPPER® / ROYAL SHOPPER® PLUS	
PEPE 2-050- [*] 22/52/62/72/82/92		UNUS SHOPPER® / ROYAL SHOPPER®	
ORTLIEB 2-082- [*] 21/51/71/81		TURA SHOPPER® / ROYAL SHOPPER® / ROYAL SHOPPER® PLUS	
LUV 2-090- [*] 12/28		UNUS SHOPPER® FUN / ROYAL SHOPPER®	
BOJE 2-092- [*] 08/09		TURA SHOPPER® / ROYAL SHOPPER® PLUS	
TRUCK A7 2-099-00		UNUS SHOPPER® FUN / UNUS SHOPPER® / ROYAL SHOPPER®	
TRUCK A9 2-199-00		UNUS SHOPPER® / ROYAL SHOPPER®	
HAVA 2-103- [*] 22/92		UNUS SHOPPER® FUN / UNUS SHOPPER® / ALU STAR SHOPPER® TREPPENSTEIGER ROYAL SHOPPER®	
VIKA 2-107- [*] 00/80		QUATTRO SHOPPER® / ROYAL SHOPPER® / TREPPENSTEIGER SCALA SHOPPER®	
LINI 2-108- [*] 70/90		SCALA SHOPPER® / SCALA SHOPPER® PLUS	
IPEK 2-112-20		SCALA SHOPPER® / UNUS SHOPPER® FUN / ROYAL SHOPPER®	
MUNA 2-123- [*] 00/80		SCALA SHOPPER® / SCALA SHOPPER® PLUS	
VARA 2-124- [*] 00/80		SCALA SHOPPER® / QUATTRO SHOPPER® / ROYAL SHOPPER® TREPPENSTEIGER SCALA SHOPPER®	
HENNI 2-125- [*] 00/80		UNUS SHOPPER® / ALU STAR SHOPPER® / QUATTRO SHOPPER® ROYAL SHOPPER® / KOMFORT SHOPPER® / TREPPENSTEIGER ROYAL SHOPPER®	
LOME 2-126- [*] 20/80		UNUS SHOPPER® / QUATTRO SHOPPER® / ROYAL SHOPPER®	
TEKIN 2-127- [*] 20/80		UNUS SHOPPER® FUN / ALU STAR SHOPPER®	
DIVA 2-128- [*] 00/80		UNUS SHOPPER® FUN / UNUS SHOPPER® / SCALA SHOPPER® PLUS / ALU STAR SHOPPER® ROYAL SHOPPER® / TREPPENSTEIGER SCALA SHOPPER®	
MIMI 2-129- [*] 00/80		QUATTRO SHOPPER® / ROYAL SHOPPER® / KOMFORT SHOPPER® TREPPENSTEIGER ROYAL SHOPPER®	
SUSI 2-130- [*] 20/90		UNUS SHOPPER® / SCALA SHOPPER® PLUS / ALU STAR SHOPPER®	

* ART.-NR. bitte um den Farbcode ergänzen / Please add colour code to article number / Code couleur en complément

TASCHE BAG / SAC	FARBEN TASCHEN COLOURS BAGS / COULEURS DE SACS	GESTELL FRAME / CHÂSSIS	EIGENSCHAFTEN TASCHE FEATURES BAG / CARACTÉRISTIQUES DU SAC
MEER 2-132-* 80/90		UNUS SHOPPER® FUN / ALU STAR SHOPPER® / ROYAL SHOPPER®	
IKO 2-133-* 50/70/80/90		UNUS SHOPPER® FUN / SCALA SHOPPER® / TREPPENSTEIGER ROYAL SHOPPER®	
EDA 2-134-* 80/90		ALU STAR SHOPPER® / ROYAL SHOPPER® / TREPPENSTEIGER SCALA SHOPPER®	
TILLY 2-135-* 50/70/80/90		UNUS SHOPPER® / SCALA SHOPPER® PLUS / ROYAL SHOPPER® / KOMFORT SHOPPER®	
KIRA 2-136-* 20/70/80/90		UNUS SHOPPER® / SCALA SHOPPER® / QUATTRO SHOPPER® / ROYAL SHOPPER® TREPPENSTEIGER SCALA SHOPPER® / TREPPENSTEIGER ROYAL SHOPPER®	
LILLO 2-137-* 70/80		UNUS SHOPPER® / SCALA SHOPPER® PLUS / ROYAL SHOPPER® TREPPENSTEIGER SCALA SHOPPER®	
ALBA 2-138-* 70/80		SCALA SHOPPER® / QUATTRO SHOPPER® / ROYAL SHOPPER® TREPPENSTEIGER ROYAL SHOPPER®	
BEA 2-139-* 20/70		UNUS SHOPPER® FUN / SCALA SHOPPER® / SCALA SHOPPER® PLUS	
LIZZY 2-140-* 70/90		UNUS SHOPPER® FUN / UNUS SHOPPER® ROYAL SHOPPER® / TREPPENSTEIGER SCALA SHOPPER®	
SILA 2-141-* 20/80		UNUS SHOPPER® / SCALA SHOPPER® PLUS / QUATTRO SHOPPER® / ROYAL SHOPPER® TREPPENSTEIGER ROYAL SHOPPER®	
CLINT 2-142-* 50/70		TURA SHOPPER® / ROYAL SHOPPER® PLUS	
FADO 2-143-* 50/70		TURA SHOPPER® / ROYAL SHOPPER® PLUS	

* ART.-NR. bitte um den Farbcode ergänzen / Please add colour code to article number / Code couleur en complément

RAD WHEEL ROUE	ART-NR:	GRÖSSE SIZE TAILLE	PASSEND FÜR SHOPPER® FITS ON SHOPPER® ADAPTABLE AU SHOPPER®	RAD WHEEL ROUE	ART-NR:	GRÖSSE SIZE TAILLE	PASSEND FÜR SHOPPER® FITS ON SHOPPER® ADAPTABLE AU SHOPPER®	RAD WHEEL ROUE	ART-NR:	GRÖSSE SIZE TAILLE	PASSEND FÜR SHOPPER® FITS ON SHOPPER® ADAPTABLE AU SHOPPER®
	3-306-80		SCALA SHOPPER® QUATTRO SHOPPER® (VORN)		3-306-90		SCALA SHOPPER®		3-311-20		SCALA SHOPPER® PLUS
	3-316-20		UNUS SHOPPER® FUN		3-322-20		ALU STAR SHOPPER®		3-321-80		QUATTRO SHOPPER® (HINTEN) KOMFORT SHOPPER®
	3-326-80		ROYAL SHOPPER® ROYAL SHOPPER® PLUS		3-332-80		ROYAL SHOPPER® ROYAL SHOPPER® PLUS KORB SHOPPER® XXL		3-341-20		ROYAL SHOPPER® ROYAL SHOPPER® PLUS FAHRRAD&FREIZEITANHÄNGER
	3-351-20		ROYAL SHOPPER® ROYAL SHOPPER® PLUS FAHRRAD&FREIZEITANHÄNGER		3-346-80		TREPPENSTEIGER SCALA SHOPPER® TREPPENSTEIGER ROYAL SHOPPER®		3-366-80		TURA SHOPPER® ROYAL SHOPPER®
	3-367-20		TURA SHOPPER® ROYAL SHOPPER®		3-307-20		NEW SCHOOL SHOPPER®		3-331-80		KORB SHOPPER®